

**JOURNAL OF
ENGINEERING & TECHNOLOGY**
(A State Level Research Journal)

Volume 1

March 2008

**GIT
J
E
T**



PLATINUM FOUNDATION MANAGED
GANDHINAGAR INSTITUTE OF TECHNOLOGY

(Approved by AICTE and Affiliated to Gujarat University)

www.git.org.in
director@git.org.in
PH: 02764 281860/61
FAX: 02764 281862

AT & PO: MOTI BHOYAN,
KHATRAJ-KALOL ROAD,
VIA. VADSAR, TA. KALOL,
DIST. GANDHINAGAR 382721

EDITORIAL BOARD

- Prof. M. N. Patel : **Chairman**
Principal, L. D. College of Engineering and
Dean, Faculty of Engineering and Technology,
Gujarat University, Ahmedabad
- Dr. F. S. Umarigar : **Co-Chairman**
Principal, BVM Engineering College and
Dean, Faculty of Engineering and Technology,
Sardar Patel University, VNagar
- Dr. K. N. Sheth : Director, Gandhinagar Institute of Technology,
Moti Bhoyan, Ta. Kalol, Dist. Gandhinagar
- Dr. S. A. Puranik : Director, Atmiya Institute of Science and
Technology, Rajkot
- Dr. N. D. Jotwani : Professor, Computer Engineering Dept.
DAICT, Gandhinagar
- Dr. Ketan Kotecha : Principal, G.H. Patel College of Engineering and
Technology, V. V. Nagar
- Dr. Y. P. Kosta : Principal, Charotar Institute of Technology,
Changa
- Dr. P. K. Shah : Professor, Mechanical Engineering Dept.,
LDCE, Ahmedabad
- Prof. U. J. Patdiwala : Assistant Professor, Mechanical Engineering Dept.,
Gandhinagar Institute of Technology
Moti Bhoyan, Ta. Kalol, Dist. Gandhinagar

From the desk of Convenor & Editorial-in-Chief

It gives me a great pleasure to release the first half yearly issue of JET-GIT i.e. Journal of Engineering and Technology of Gandhinagar Institute of Technology.

At present this journal is aimed at disseminating the research conducted by technocrats from all over the state and bring them to a common platform for enhancing and strengthening the communication in the areas of various streams of engineering. It is needless to state that the ultimate goal is to bring the research workers of our nation together by organizing national level symposium so that the interaction will make meaningful contributions to the nation.

At the outset, I take an opportunity to convey my feelings of gratitude to all the members of editorial board who have promptly given their consents to be the members of the board and help in accomplishment of the mission of this research Journal.

The mission of the Hon'ble Trustees of the Platinum Foundation, the anchor and mentor of Gandhinagar Institute of Technology is to produce the scholars, having innovative and creative skills in the field of engineering. To achieve this mission, our trustees of platinum foundation have always shown earnestness to invest in any of the activities leading to educational and research excellence. The present publication is one of the illustrations of the same.

I therefore take an opportunity to convey my heartiest feelings of gratitude to them as they have been always a constant source of motivation and inspiration in all the academic activities. I am sure that the regular publishing of this half-yearly journal of engineering and technology of this institute will comply with the desire of our trustees to excel in the field of engineering research.

I also convey my feelings of gratitude for contributions made by the authors in the first issue of this journal and showing the keen interest to join the mission of this institute.

I am sure more and more contributions would come forth from eminent researchers so that we can bring more laurels in our pursuit of excellence in the area of engineering and technology.

Gandhinagar Institute of Technology

Dr. K. N. Sheth
Director

Editorial

Changing role of Engineers : From Conventionalism to Innovation

The role of engineers in the present era has drastically changed and research, innovation and creativity have replaced the conventional modus-operendi in all the areas of engineering. National Academy of Engineering, USA has taken up the project on 'Educating Engineers of 2020' adapting engineering education to the new century. This project basically concentrates on future vision on the changing role of engineers. Today there is a tremendous advancement in knowledge and capabilities of engineers due to computerization. The students of engineering Institutes also have been showing great curiosity, ambition and understanding at the earlier period of their studies.

The global economy is the principal driving force for innovation in the industry. Research has been a motivational factor not only for academics but also for the industry. It has become very significant to conduct investigation programmes to determine new materials, innovative methods in engineering and replace the costly materials, complex procedures and expansive products.

The explosion of research globally needs to be systematically reviewed and fusion of academic and industry through interactions at the international forum is indispensable.

This is the most exiting period in the human history where research and its culmination to practice are essential. The engineering education is also required to be reinvented in light of the above facts and research methodology research projects must be covered at the under graduate level. At M.Tech level research on pilot plant studies and at Ph.D. level research at actual plant scale should be made compulsory.

Recent advances in technology have shown reduced projects risks and proactive applications leading to less expensive production. The role of engineer, therefore, should be research oriented to face challenges of future.

Dr. K. N. Sheth
Chairman & Convenor

II

CONTENTS

From the desk of Chairman and Convenor Dr. K. N. Sheth	I
Editorial Dr. K. N. Sheth	II
Extent of air pollution due to construction of port at Hazira Dr. K. N. Sheth & Hemang Patel	1
Design of helical feed for parabolic reflector antenna Jagdish M. Rathod, Akshat C. Patel & Dr. Y. P. Kosta	6
Measurement placement- network observability & bad data detection for Power system state estimation Rakesh J. Motiyani & Dr. Ajit R. Chudasama	11
Removal of cadmium (ii) and chromium (vi) using OPAC and PAC Dr. K. N. Sheth & Rohini V. Patel	16
Application of PCA in face recognition and performance of PCA based FRS system Mehfuza Holia & Mr. Vinay Thumar	20
A comparative analysis of travelling salesman problem using vectored evaluated genetic algorithm and niched pareto genetic algorithm methods Kinjal U. Adhvaryu	28
Heat Exchanger Networking for the Ammonia plant using Pinch Technology U. J. Patdiwala, S. P. Patel & P. G. Choksi	34

EXTENT OF AIR POLLUTION DUE TO CONSTRUCTION OF PORT AT HAZIRA

Dr. K. N. Sheth

Director
Gandhinagar Institute of Technology
Tal.-Kalol, Dist.-Gandhinagar

Hemang Patel

Student, Post Graduate Department
(Environmental Engineering)
ISTAR, Vallabh Vidyanagar-Gujarat

ABSTRACT

An attempt has been made to determine the extent of air pollution by measuring the Suspended Particulate Matter and Gaseous Pollutants due to construction of port at Hazira. It has been observed that the SPM concentration at station 1 is found to exceed the permissible limits during the working hours and silent hours on all the monitoring days. At station 2 and 3 the pollution is moderate. Both SPM and gaseous pollutants concentration are found to be moderate at monitoring station -2 and 3. From the Air quality index, station 1 during the working hours is found to be under "severe air pollution zone". (AQI is >100 for 62.5% of period). The gaseous pollutants have been found to be below the permissible limit. Immediate measures are required to control the air pollution at station 1 by installing air pollution control equipment and increasing the frequency of sprinkling. If possible continuous sprinkling system should be developed for controlling the SPM

Introduction

Gujarat Maritime Board (GMB) on behalf of State Government awarded rights to according to the Royal Dutch/shell groups of companies to develop "LNG (Liquefied Natural Gas) driven", multi-cargo deep water all weather port at Hazira. The port project Hazira includes marine infrastructure like break water basin and reclamation, construction of 5 mtpa (million tones per annum) LNG storage terminal with send out facilities. The LNG terminal is also proposed to be connected to Gujarat gas and GSPL (Gujarat State Petroleum Limited) grid to connect to the various bulk gas consumers.

The construction activities for the said project will obviously have an impact on the environment.¹ The objective of present study is to study the extent of impact on air environment Basic construction activities affecting environment are as under:

1. Diesel emission on account of use of DG set.
2. Operation of Cranes for lifting of boulders and such others building materials.
3. Batching and mixing plant operation for preparation of concrete mix
4. Excavation work².

Materials and Methods

The samples were collected for six month January 2004 to June 2004. high volume sampler (AP 430) was used to collect the samples. Samples were collected in order to observe following parameters

1. Suspended particulate matter for six month.
2. Sulfur dioxide for six month.
3. Oxides of Nitrogen for six month (The results reported in form of graphical representation however are been only for one month)

The methods of measurement for various gaseous pollutants and the SPM is strictly in accordance with IS 5182- 1975.

The samples were analyzed in the Environmental Laboratory of M/S de Tox Corporation, 3rd Floor, K. G. Chamber, Udhna Darwaja, Ring Road, Surat-395 002. The high volume sampler, dust fall analyzer and stack monitoring kits were also provided by M/S de Tox Corporation, Surat.

Selection of Monitoring Stations

For the purpose of designing the network to assess the exposure and compliance with guidelines, exposure assessment was carried out at the selected location where maximum pollutant concentration was envisaged to build up reasonably complete picture of the exposure patterns. For the purpose of ambient air monitoring three stations were selected in the given area.

Monitoring Station - 1

This location is important site in the storage area. This is located 10 m from the 30 m³ batching plant for construction of cryogenic storage tank. This will also help in assessment of the pollutants on account of screening plant and cement silo. This station has been identified because of this likely to give reasonably high amount of air contaminants.

Monitoring Station - 2

This station located on the principal Assess road near ICBC work office. Primary this location selected because it may give the sufficient idea about the pollutants, generated on account of construction vehicular traffic. This will also includes the parking area of ICBC work office. The contractors park normally many construction commercial vehicles like dumper, Cranes, JCB etc.

Monitoring Station - 3

This is located 5 m far from the main entrance on the principal roads. All the

vehicles have to pass through this area. This is the station, which will give the highest automobile emission as SO₂, NO_x and SPM compared to other stations.

Results & Discussion³

Fig. 1 and 2 show the values of the SPM for monitoring station 1, 2 and 3 respectively for the month of January 2004. From these figures it is clear that the SPM concentration is very high at station 1 as the particulate matter generated from batching plant is very high.

The SPM concentration at station 1 is observed to exceed the permissible limits during the working hours and silent hours on all the monitoring days⁴. This may be on account of the following factors:

a) The access road leading to the jetty is closed because of excavation activities being conducted by Simplex concrete pile Ltd. Thus the alternate route having loose soil which passes from Station B is excessively in use. The heavy vehicular movement caused thereof results in increased SPM.

b) Around 15 m from the Station B, the Batching and Screening Plants of Punj -Lloyd Ltd. (PLL) are in operation, which may contribute to increase in the SPM concentration.

c) Around 10 m behind Station B, the centralized concrete storage yard is located. The dumping of concrete waste also contributes to increase in SPM.

d) It has been observed that the frequency of water sprinkling is less as compared to the other areas.

Station 2 and 3 are Office and entrance gate area. The SPM concentration therefore is found to be low compared with station 1 located near 30 m³ batching plant. At station 1 the SPM concentration is almost exceeding the permissible limit of 500µg/m³. The highest concentration in the month of January was observed on 30/01/2004, which was 4028 µg/m³ during the working hours. However

23/01/2004 the SPM concentration was highest during the silent hours, which was 2800 $\mu\text{g}/\text{m}^3$.

The SPM concentration at Station 2 is observed to exceed the permissible limits on 30/01/2004, which is 790 $\mu\text{g}/\text{m}^3$. This may be on account of heavy vehicular movement during the monitoring period on these days.

The quality of ambient air for station -3 very clearly show that SPM is almost within the permissible limit except on 03/01/2004, 30/01/2004, which is 666 $\mu\text{g}/\text{m}^3$ and 790 $\mu\text{g}/\text{m}^3$. So far as the SPM in the ambient air at Station 3 is concern the value are found is within limit except on 20/01/2004 during the working hours.

Measurements of SO_2 and NO_x in the ambient air at all the three station have been graphically presented in Fig.-3&4 and Fig.-5&6, it is clear that during the

month January 2004 the gaseous pollutants are found to be of very low concentration. The range of concentration of SO_2 during the month of January 2004 was found to vary between 0.31 $\mu\text{g}/\text{m}^3$ to 4.57 $\mu\text{g}/\text{m}^3$. Similarly NO_x during the month of January 2004 range between 13.40 $\mu\text{g}/\text{m}^3$ to 48.73 $\mu\text{g}/\text{m}^3$. Partially this may be because of M/S Reliance Petrochemicals located 15 km far from this area.

**Ambinet Air Monitoring
SPM(Peak Working Hours)**

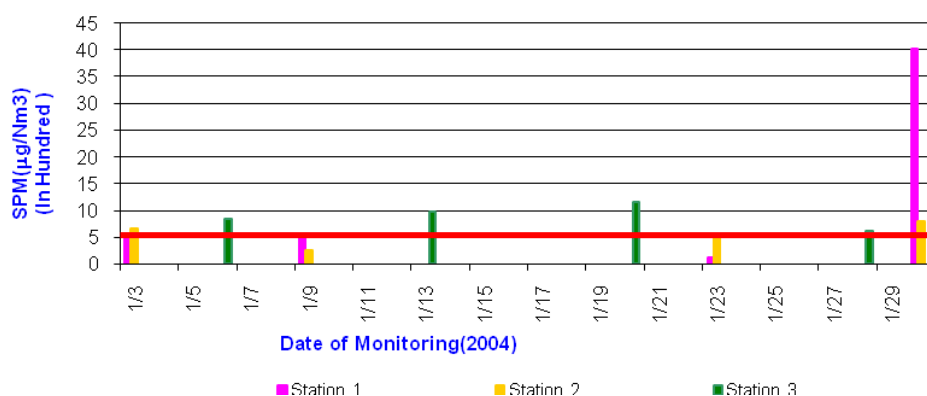

Ambient Air Analysis SPM (Reduced Working Hours)

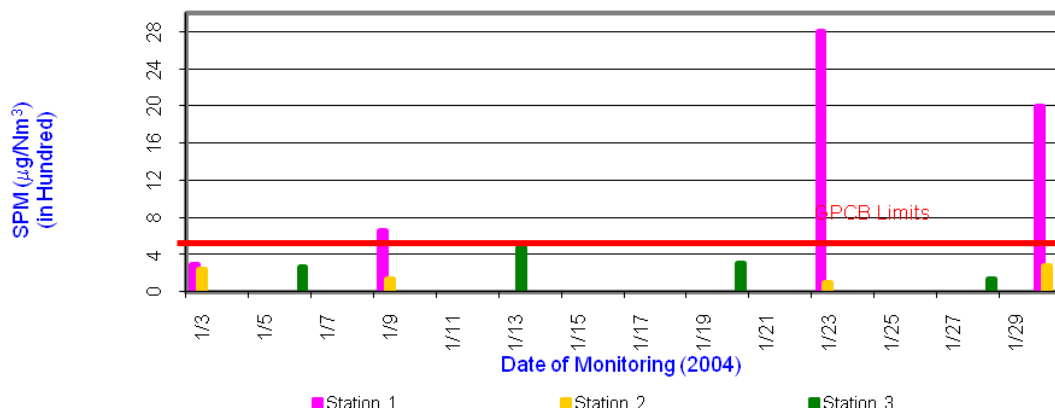

Ambient Air Analysis SO₂ (Reduced Silent Hours)

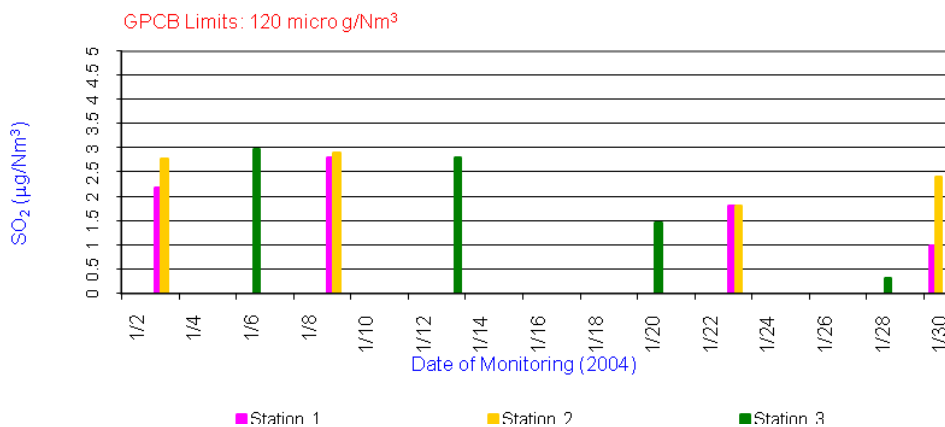

Ambient Air Analysis SO₂ (Peak Working Hours)

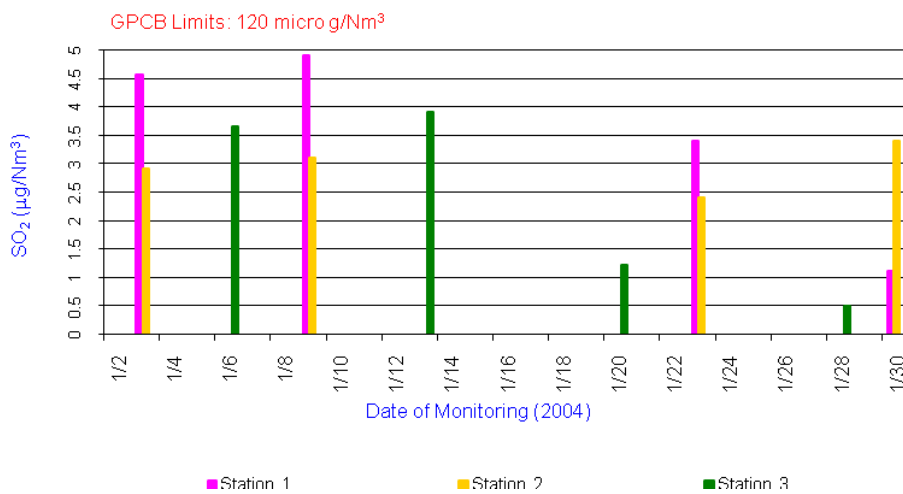

Ambient Air Analyse NOx (Peak Working Hours)

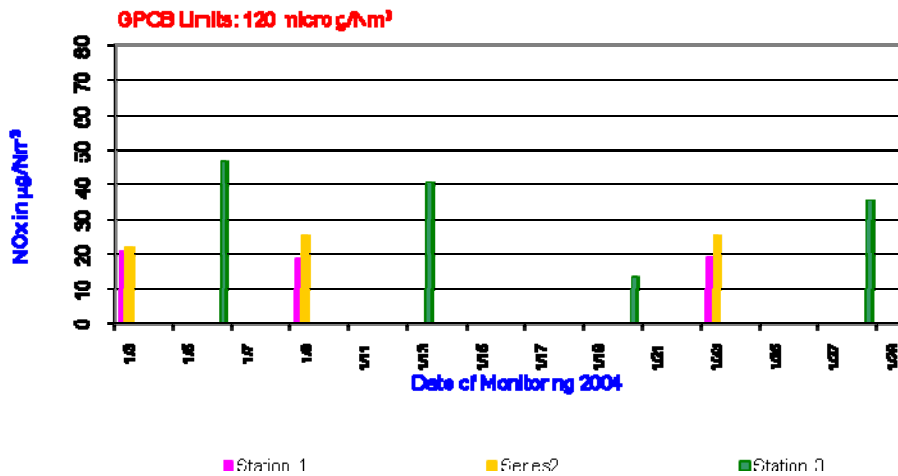

Ambient Air Analyse NOx (Reduced Working Hours)

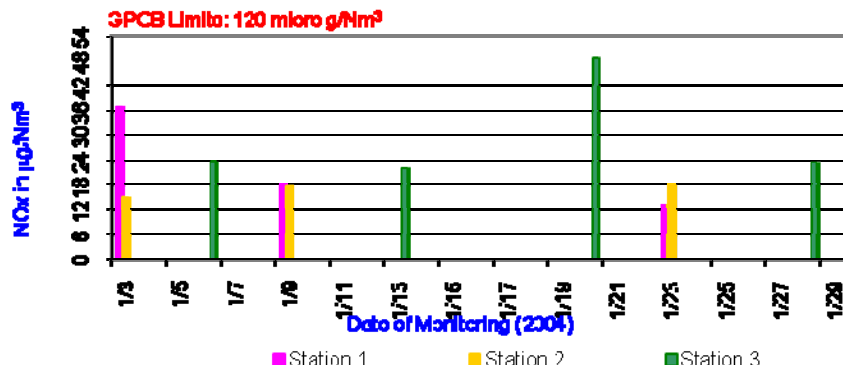

SUMMARY OF CONCLUSIONS

Following conclusions can be drawn:

- 1) The maximum concentration of the SPM is found at station 1 which clearly discerns highest level of traffic vehicular pollution and batching plant operation near the monitoring station 1.
- 2) At station 2 and 3 the pollution is moderate. Both SPM and gaseous pollutants concentration are found to be moderate.
- 3) Immediate measures are required to control the air pollution at station 1 by installing air pollution control equipment and increasing the frequency of sprinkling. If possible continuous sprinkling system should be developed for subsiding the SPM
- 4) The quality of ambient air, so far as the gaseous pollutants are concerned

is not much damaging due to construction. The concentration of all the gases at all the stations remains almost very low. This lower values is also on account of the pollution of M/S Reliance Petrochemicals Ltd located 15 km far from the this place.

5) From the Air quality index, station 1 during the working hours is found to be under “severe air pollution zone”. (AQI is >100 for 62.5% of period). Similarly station 2 and 3 are also under the “severe air pollution zone”. (AQI is >100

for 42% of period). During the silent hours the station. 1 falls into category of “moderate air pollution zone”. However station 2 is under the “clean air pollution zone” the station 3 is fall under “light air pollution zone”.⁵

REFERENCES

1. Larry W Canter, 'Environmental Impact Assessment' Irwin McGraw Hill, N.Y, 1996, pp145-185.
 2. "Indicators of the Environmental Impacts of Transportation", U.S EPA 1996, pp63-67.
 3. Hemang K Patel, 'Extent of Air Pollution Due to Construction of Port at Hazira' M.E. Thesis guided by Prof Dr K N Sheth and submitted to Sardar Patel University on December 2004
 4. 'Guidelines for Air Quality' WHO 2000, pp 4-47.
- T. Senthilnathan and R.D. Rajan, "Ambient Air Analysis by Air Quality Indexing Method". Environmental Pollution Control Journal Vol. 6 no: 1 Nov-Dec 2002.

DESIGN OF HELICAL FEED FOR PARABOLIC REFLECTOR ANTENNA

Jagdish M. Rathod,
Lecturer,
Electronics Department,
BVM Engg. College, VV Nagar

Akshat C. Patel
PG Student of EC Department
Charotar Institute of Technology
Changa, -Gujarat

Dr. Y. P. Kosta
Principal
Charotar Institute of Technology
Changa-Gujarat

ABSTRACT

Helical antennas have long been popular in applications from VHF to microwaves requiring circular polarization, since they have the unique property of naturally providing circularly polarized radiation. One area that takes advantage of this property is satellite communications. Where more gain is required than can be provided by a helical antenna alone, a helical antenna can also be used as a feed for a parabolic dish for higher gains. As we shall see, the helical antenna can be an excellent feed for a dish, with the advantage of circular polarization. One limitation is that the usefulness of the circular polarization is limited since it cannot be easily reversed to the other sense, left-handed to right-handed or vice-versa.

Key Words: Helical Antenna, Parabolic Dish Feed

Introduction

The main purpose of the paper is to point out low cost and high gain feed design for parabolic dish of 600mm diameter. Designed feed is very small of only 2.5 turns and provides RH e they are seen virtually every where on automobiles, building, ships, a circular polarization. The helix is only a small fraction of wavelength in diameter and acts as a guiding structure [1]. This is considering in wire antenna category which is familiar because aircrafts, spacecraft and so on [2], the helix is a basic three-dimensional geometric form. A helical wire on a uniform cylinder becomes a straight wire when unwound by rolling the cylinder on a flat surface. Viewed end-on, a helix projects as a circle. Thus, a helix combines the geometric forms of a straight line, a circle and a cylinder.

1.2 Reflector Antenna

The success in the exploration of outer space has resulted in the advancement of antenna theory.

Because of the need to communicate over great distances, sophisticated forms of antennas had to be used in order to transmit and receive signals that had to travel millions of miles. A very common antenna form for such an application is a parabolic reflector shown in Figure 1.11 (a) and (b). Antennas of this type have been built with diameters as large as 305 m. Such large dimensions are needed to achieve high gain required transmit or receive signals after millions of miles of travel.

There are three types to feed a parabolic dish.

- CENTER FEED
- OFFSET FEED
- CASSEGRAIN FEED

A feed is the main point of contact between the dish and the coaxial cable or a wave guide. In short, we can say that a feed is a medium of communication for the dish. It means that by means of the feed, we can communicate with the dish, of course the communication is bidirectional. i.e., we can transmit as well

as receive waves with the help of the dish. Various types of feeds used for a parabolic dish are shown below. In the Center feed type, we are feeding the dish exactly from the center to its focal point to get the proper illumination and to achieve the maximum gain as much as we can get. One type of center feed is shown in the figure below. Another type of feeding method is offset feed, in this method as shown in the figure, only certain part of the dish is being illuminated. The offset feed is used in very specific applications like satellite communications.

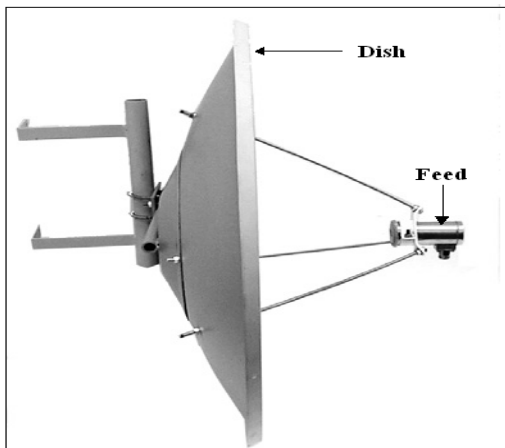
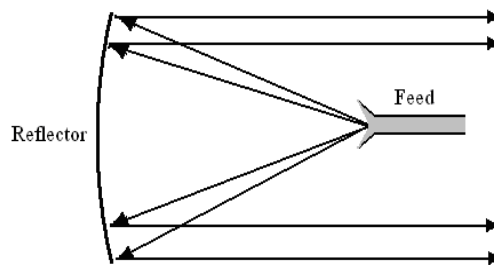

Figure.1. Center feed



Figure. 2. Offset Feed Figure. 2. Offset Feed



(a) Parabolic reflector with front feed

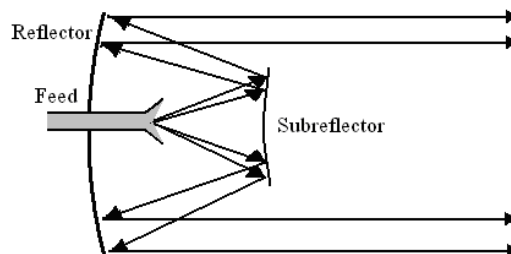

(b) Parabolic reflector with cassegrain feed

Figure.3. Typical reflector configurations

Design & Calculation

Helical antennas are relatively broadband, typically useful over a range of frequencies relative to the helix circumference of $3/4\lambda$ to $4/3\lambda$, or roughly a 60% bandwidth. The radiation patterns are much more useful.

Thus, the main advantage of the broadband characteristic of the helical antenna is that the dimension is not critical. The ratio f/D (focal length/diameter of dish) is the fundamental factor governing the design of the feed for a dish. The ratio is directly related to the beam width of the feed necessary to illuminate the dish effectively.

- R= Diameter of Ground Plane
- D = Diameter of Helix
- S = Axial Linear Distance (Spacing) Between Two Windings
- d = Wire (coil) Thickness
- C = Circumference of Winding
- α = Pitch Angle

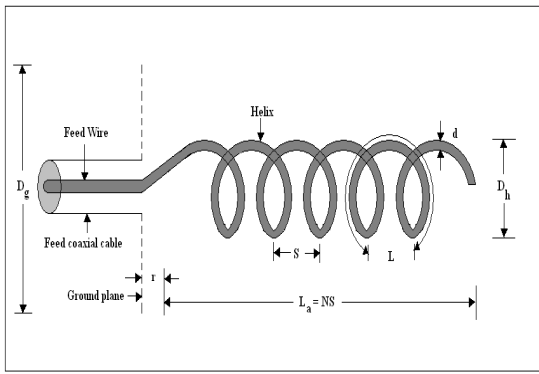

Figure. 4. A Sketch of a Helical Antenna

The input information required to start the design procedure consists of the frequency range and the central frequency, f_c the required maximum antenna gain, the allowed variations in the gain, the axial ratio, and the required relative bandwidth. To illustrate the design procedure we have designed a helical feed for the parabolic reflector having diameter (D) of 600mm, focal length (f) of 270mm and depth of dish (d) is 83mm. From the dimension of the dish the f/D ratio turns out to be 0.45. As discussed above f/D ratio is the key factor in the design of the feed for the dish see in fig 4. Feed design is carried out for the frequency range of 2.4 GHz to 2.5 GHz with center frequency equal to 2.45 GHz. All helical dimension equations are in terms of wavelength. For 2.45 GHz center frequency value of λ is 0.1224 m i.e. $\lambda = 122.4$ mm. All the parameter mentioned in the above figure can be calculated. The coil or wire thickness is about $\lambda/100 = 1.22$ mm. Now for the required turns spacing of 20mm and directivity of about 4 db, circumference and the diameter of the coil is obtained as 99.74mm and 31.74mm respectively. Pitch angle $\alpha = 11.33^\circ$ and gain of helical without reflector is 9.03 dB. From the conventional approach the theoretical value of all required parameters are calculated. The experimental set up included reference antenna that works at the same operating frequency at which helical feed had to operate. A patch antenna having gain of 7 db and operating frequency of 2.45 GHz has been employed for the purpose. The

results of the experiments with reflector are provided in the next section.

Frequency of operation: 2.4GHz – 2.5 GHz.

Center Frequency f_c : 2.45 GHz

$$\therefore \lambda_c = c / f_c \quad (1)$$

$$\therefore \lambda_c = 122.4 \text{ mm}$$

Helical winding (coil) thickness (d):

$$d = \frac{\lambda}{100} \quad (2)$$

$$\therefore d = 1.22 \text{ mm}$$

Required spacing (s) = 20 mm

Required Directivity = 4.069 db

Directivity (D)

$$D = \frac{15C^2NS}{\lambda^3} \quad (3)$$

$$\therefore C^2 = \frac{D\lambda^3}{15NS}$$

$$\therefore C^2 = \frac{4.069 \times (122.4)^3}{15 \times 2.5 \times 20}$$

$$\therefore C = 99.74 \text{ mm}$$

But $C = \pi D$

$$\therefore D = 31.74 \text{ mm}$$

Parabolic Disc

A very common antenna form for such an application is a parabolic reflector. Antennas of this type have been built with diameters as large as 305 m. Such large dimensions are needed to achieve high gain required transmit or receive signals after millions of miles of travel. Some of the AMSAT satellites and others require more than 15 dB gain with circular polarization for good reception. Until someone finds an optimization that yields higher gain from a long helix, some other antenna type is needed; a parabolic dish is often a good choice. While a large dish can provide gains upward of 30 dB, a small dish can easily provide the 20 to 25 dB gain needed for many satellite applications. The beam width of a small

dish is broader than the beam of a large dish, making tracking less difficult. Of course, the dish needs a feed antenna, and a short helix is a good choice for circular polarization. A small offset dish is very attractive, since the feed blockage, which degrades small dish performance is greatly reduced.

Results and Discussions

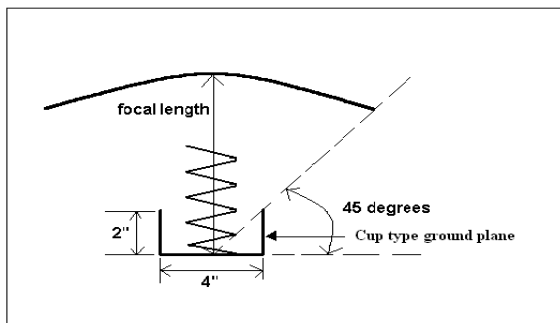

Figure 5. Helical antenna with cupped ground plane illuminating the Parabolic dish properly.

Parabolic dish antenna is the most commonly and widely used antenna in communication field mainly in satellite and radar communication. The feed designs for the parabolic dishes are having their own advantages over conventional feed. From a practical point of view, the antenna's length, L , is an important design parameter. Hence, we set a goal to maximize the gain for a given normalized length. The gain of the parabolic dish with center feed of helical has been measured for the different shape and size of the helix ground plane. Requirement of the helical feed arises from the need of circular polarization.

It's having Right Hand Circular Polarization operating at center frequency of 2.45 GHz. Helical feed with reflector dish having maximum gain of 23 dB (circular ground plane of 110 mm diameter fig 2) and 22 dB (octagon ground plane). Not only gain but we got excellent result for VSWR i.e. 1.19 & return loss 21 dB with just only 2.5 turns of coil. Its design is simplest of all

antennas with coil wound on core. See in fig 6.

Value observed are Return Loss = 21 db
VSWR = 1.19.



Figure 6. Helical antenna with ground plane.

Conclusion

Requirement of the helical feed arises from the need of circular polarization. It's having Right Hand Circular Polarization operating at center frequency of 2.45 GHz. Helical feed with reflector dish having maximum gain of 23 dB (circular ground plane of 110 mm diameter fig 6) and 22 dB (octagon ground plane). Not only gain but also we got excellent result for VSWR i.e. 1.19 & return loss 21 dB with just only 2.5 turns of coil. Its design is simplest of all antennas with coil wound on core.

Acknowledgement

Authors are thanks to Dr C L Patel, chairman Charutar Vidya Mandal (CVM), Vallabh Vidyanagar-Aanad, Gujarat for his continuously inspiration for writing a technical paper to all Engineering institutes (ADIT, BVM, and GCET) faculties.

The Authors also would like to thanks Principal & H.O.D, Electronics Department of B.V.M.Engg.College for their support and Encouragements, V.V.Nagar and Twin Engineers, Baroda for given testing and development facility for this work.

References

- [1] Kraus, J.D. & Marhefka, R.J., Antennas: for All Applications, third edition, Publisher McGraw-Hill, 2002.J.D.Krauss, Location, Date, pp. 222-223, 347-348
- [2] C.A.Balanis Publisher, Location, Date, pp 4-5,785-786
- [3] Helical Feed Antennas Paul Wade W1GHZ ©2002
w1ghz@arrl.net pp 8-23
- [4] Kraus, J.D., (W8JK), "A Helical-Beam Antenna without a Ground Plane," IEEE Antennas and Propagation Magazine, April 1995, p. 45.
- [5] Emerson, D., "The Gain of the Axial-Mode Helix Antenna," Antenna Compendium Volume 4, ARRL, 1995, pp. 64-68.
- [6] Nakano, H., Yamauchi, J., & Mimaki, H., "Backfire Radiation from a Monofilar Helix with a Small Ground Plane," IEEE Transactions on Antennas and Propagation, October 1988, pp. 1359-1364.
- [7] Nakano, H., Mikawa, T., & Yamauchi, J., "Investigation of a Short Conical Helix Antenna," IEEE Transactions on Antennas and Propagation, October 1985, pp. 1157-1160.
- [8] Kraus, J.D., "A 50-Ohm Impedance for Helical Beam Antennas," IEEE Transactions on Antennas and Propagation, November 1977, p. 913.
- [9] G. A. Thiele and W. L. Stutzman, Antenna Theory and Design, New York, J. Wiley, 1981.
- [10] T. E. Tice and J. D. Kraus, "The Influence of Conductor Size on the Properties of Helical Beam Antennas," Proc. IRE, 27, November 1949, p. 1296.
- [11] H. E. King and J. L. Wong, "Characteristics of 1 to 8 Wavelength Uniform Helical Antennas," IEEE Transactions on Antennas and Propagation, AP-28, March 1980, pp. 291-296.
- [12] J. L. Wong and H. E. King "Empirical Helix Antenna Design," IEEE International Symposium on Antennas and Propagation, May 1982, pp. 366-369.
- [13] D. T. Emerson, "The Gain of the Axial-Mode Helix Antenna," Antenna Compendium, 4, (ARRL), 1995, pp. 64-68.
- [14] Helical Antenna Design Curves,
"http://www.poynting.co.za/Tech_training/helical.html.

MEASUREMENT PLACEMENT- NETWORK OBSERVABILITY & BAD DATA DETECTION FOR POWER SYSTEM STATE ESTIMATION

Rakesh J. Motiyani,
Assistant Professor
Electrical Engineering Department
Mahatma Gandhi Institute of Technical
Education & Research, Navsari

Dr. Ajit R. Chudasama,
Professor, Faculty of Engineering &
Technology
M S University,
Baroda

ABSTRACT

The paper gives an idea of generalized state estimation that includes network topology, measurement placement, observability of power system network and bad data detection. This paper includes discussion of IEEE transactions on power system network topology, meter placement, network observability and bad data processing which is incorporated with power system state estimation. This paper suggests simulation of reliable and accurate state estimation in which user can change network topology and select minimum number of measurements for observability of inter connected power system.

Key words : Bad data detection, measurement placement, network observability, network topology, State estimator.

Introduction

In the late 1960's, an advanced computer-aided system was devised for operators that allows for the monitoring of switching device statuses and electric quantities such as power flows, power injections, node voltage magnitudes, logs of data, alarms and graphic displays. This system is generally referred as the Supervisory Control and Data Acquisition or SCADA.

In addition to the vast amount of system information made available, research led to the development of many analytical programs that allow for a broad scope of analysis, control and security functions. Originally, engineers thought that the newly developed analytical tools could make direct use of the measurements provided by the SCADA, but this turned out to be quite wrong. These functions require a coherent picture of the state of the network as a starting point, such as what is provided by a power flow.

The goal of control center design is security control under the three states of power system operation: the normal, emergency, and restorative states. There are several functions performed by a control center in the real-time environment. The essential functions include security monitoring, on-line power flow, security analysis, supervisory control, automatic generation control, automatic voltage/VAR control and economic dispatch control. Since all of these functions are directly dependent on state estimation, it is essential that the system operators trust the results it provides.

The state of electrical power system is defined by the vector of voltage having magnitude and angle at all network buses. The static state estimator is the data processing algorithm for converting redundant and not so reliable meter readings and other available information about the network connectivity into an estimate of the static state vector.

Static state estimator is related to conventional power flow calculations. However, the static state estimator is designed to handle the many uncertainties associated with trying to do an online power flow for an actual system using meter reading telemetered in real time to a digital computer. Uncertainties arise because of meter and communication errors, incomplete metering, error in mathematical model, unexpected system changes etc. These uncertainties make difference between the usual power flow studies done in office and online state estimation done as a part of control system.

Document Survey

The basic theory and computational requirements of static state estimation are presented in the paper by Robert E. Larson and William F. Tinney [1]. The paper by F. C. Schweppe [2], gives definition and the most fundamental concept of power system static state estimation. In part II of the same paper [3], the approximate model of the static state estimation is discussed. In part III of the paper by F.C.Schweppe [4], the implementation part of the power system static state estimation is discussed.

The paper by A. Monticelli [5], gives idea of generalized state estimation that includes network model, topological processor, observability of power system network and bad data processing. By the same author [6], WLS state estimator, topological processor, observability analysis and bad data analysis is discussed in detail. This paper also includes concept of observable islands.

The paper by E. Handschin and F.C. Schweppe [7], describes sum of squares of residuals method of bad data detection and identification. A comparative study of bad data identification methods illustrated in [8] by L.Mili and Th. Van Cutsem. The paper by G.R Krumpholz and K.A Clements [9], outlines the theoretical basis for an algorithm for determining observability. Algorithm for observability

of network containing both bus injections and line flows measurements is presented.

Network observability is also discussed in the paper by A. Monticelli [10]. Two algorithms are presented in this paper: one for (I) testing the observability of network and (II) to identify the observable islands when network is unobservable, and the other for selecting minimal set of additional measurement to make system observable. The two algorithms are based on triangular factorization of the gain matrix. Example of six bus system is also presented in this paper. This paper also gives measurements that must be used for IEEE 14 bus system to make the system observable.

In the paper by A. Monticelli [11], a complete theory of network observability is presented. Starting from fundamental notation of network observability, unobservable branches, observable islands, etc. are discussed in this paper.

The paper By Carlo Muscas, Fabrizio Pilo [12], proposes an optimization algorithm suitable to choose the optimal number and position of the measurement devices needed to operate management and control issues, such as energy dispatching and protection coordination, in modern electric distribution networks.

The paper by Jian Chen and Ali Abur [13], discusses replacement of critical measurement detected as bad data with phase measurement units to make power system observable.

On the basis of above document survey following simulations are found feasible.

(A) Network Topology Processor

The topology processor identifies network configuration based on the network connectivity model and dynamic switch status. It produces the visual model of energized and de energized part of inter connected power system for analysis purposes. Here for sake of simulation of

the topology processor, different kinds of programming can be adopted as following.

- (a) Addition of the link
- (b) Removal of the link
- (c) Modification of generation
- (d) Modification of load

For implementation purpose, the data files of the network, i.e. bus data file and line data file are altered then the formation of Y bus is required to be carried out.

(B) Measurement Placement

State estimation uses a set of measurements consisting of bus injections, line flows and bus voltages which are collected through the Supervisory Control & Data Acquisition system.

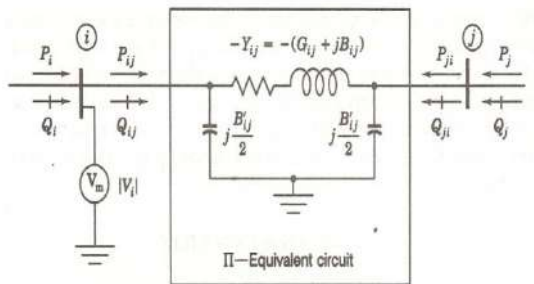

Fig. 1 Possible measurements

The main objective in designing metering scheme is to satisfy the following requirements.

- (a) Cost
- (b) Accuracy
- (c) Reliability
- (d) Bad Data Processing

(C) Network Observability

Question regarding network observability arises to assure that the metering system will provide a reliable state estimate even under such contingencies as telemetry failures and line outages. The design goal is to assure network observability

under such contingencies. An observability test should be executed prior to performing the state estimation. If the network is observable, state estimation may proceed. Otherwise, additional measurements are required. These additional measurements can be in the form of pseudo-measurements.

(D) Bad Data Processing

The Weighted Least Square estimator is highly sensitive to erroneous measurement, referred to as bad data. Therefore, post-state estimation procedures have been incorporated to the SE function for the identification and elimination of bad data. The most commonly used tool for this purpose is the normalized residual test.

Scope of Work

Network connectivity status and available data of interconnected power system in the form of bus data and line data file can be updated using network topology processor.

Power flow solution of the available network will provide bus voltage, line flows and bus injections. Available voltage magnitude, line flows and bus injections provided by load flow can be treated as real time measurements after addition of noise. Metering scheme must satisfy essential requirements as discussed earlier.

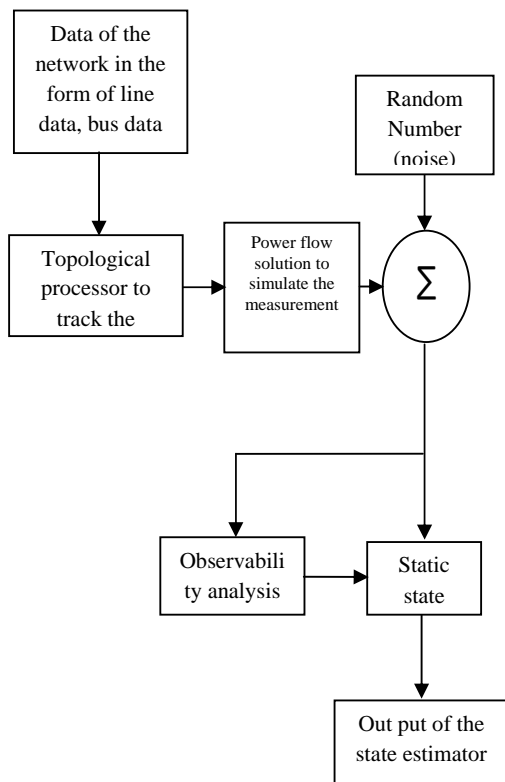

Fig. 2
Block Diagram- State Estimator

Observability of network should be tested prior to the state estimation for reliable output. Bad data identification & elimination from the available set of measurement is necessary for accurate output of state estimator.

Conclusion

State estimation is a key function in determining real-time models for interconnected networks as seen from Energy Management System. A real-time model is extracted at intervals from snapshots of real-time measurements. It is generally agreed that the emerging energy markets will demand network models more accurate and reliable than ever. This can only be achieved with state estimators that can reliably deal with topology status and parameter estimation. With that in mind, this paper has reviewed the principal developments in state estimation and related areas such as observability analysis, bad data processing, network topology processing,

topology estimation, and parameter estimation.

Acknowledgment

The authors gratefully acknowledge the contribution of Mr. Samir Desai for the technical guidelines and Mr. Hitesh Solanki for offering his helping hand during preparation of this paper.

References

- [1] Robert E. Larson, William F. Tinney, John Peschon. State estimation in power systems – Part I: Theory and feasibility. IEEE transaction on power apparatus and system, vol. PAS-80, No. 3, March 1970.
- [2] Fred C. Schweppe and J. Wildes. Power system static state estimation part I : Exact model. IEEE transaction on power apparatus and system, vol. PAS – 89, No. 1, January 1970.
- [3] Fred C. Schweppe and Douglas B. Rom. Power system static state estimation part II : Approximate model. IEEE transaction on power apparatus and system, vol. PAS – 89, No. 1, January 1970.
- [4] Fred C. Schweppe. Power system static state estimation Part III: Implementation. IEEE transaction on power apparatus and system , vol. PAS – 89 , No. 1 , January 1970.
- [5] A. Monticelli. Generalized state estimation. IEEE transaction on power system, vol. 13, No. 3 , August 1998.
- [6] A. Monticelli. Electrical power system state estimation. Proceeding of IEEE, vol. 88, No. 2, February 2000.
- [7] E. Handschin , F.C Schweppe , J. Kohlas , A. Fiechter. Bad data analysis for power system state estimation. IEEE transaction on power apparatus and system, vol. PAS-94, no. 2, March/ April 1975.
- [8] L.Mili, Th. Van Cutsem and M. Ribbens-Pavella. Bad data identification methods in power system state estimation – A comparative study. IEEE transaction on power apparatus and system, vol. PAS-104, No. 11, November 1985.
- [9] G. R. Krumpholz, K. A. Clements and P. W. Davis. A power system observability: A practical algorithm using network topology. IEEE transaction on power apparatus and system, vol. PAS-99, No. 4, July/Aug 1980.
- [10]A. Monticelli, Felix F.Wu. Network Observability: Identification of observable islands and measurement placement. IEEE

transaction on power apparatus and system, vol. PAS-104, no.5, May 1985.

[11]A. Monticelli, Felix F.Wu Network Observability: Theory. IEEE transaction on power apparatus and system, vol. PAS-104, no.5, May 1985.

[12]Carlo Muscas, Fabrizio Pilo. Optimal Placement of Measurement Devices in Electric Distribution Systems. IMTC 2006 – Instrumentation and Measurement Technology Conference Sorrento, Italy 24-27 April 2006.

[13]Jian Chen and Ali Abur. Placement of PMUs to Enable Bad Data Detection in State Estimation. IEEE transaction on power systems Vol. 21, No. 4, November 2006.

[14] Carlo Muscas, Fabrizio Pilo, Giuditta Pisano, Sara Sulis. Considering the uncertainty on the network parameters in the optimal planning of measurement systems for Distribution State Estimation. Instrumentation and Measurement Technology Conference - IMTC 2007 Warsaw, Poland, May 1-3- 2007.

REMOVAL OF CADMIUM (II) AND CHROMIUM (VI) USING OPAC AND PAC

Dr. K. N. Sheth

Director
Gandhinagar Institute of Technology
Tal.-Kalol, Dist.-Gandhinagar

Rohini V. Patel

Student, Post Graduate Department
(Environmental Science)
ISTAR, V V Nagar-Gujarat

ABSTRACT

Activated charcoal derived from waste orange peels was found to have a good non conventional adsorbent used for the removal of Cd (II) and Cr(VI) from aqueous solution. The results obtained from the orange peels activated carbon (OPAC) have been compared with commercially available powdered activated carbon (PAC). At the optimum conditions the maximum removal using 50 mg/50 mL OPAC was found to be 65.44% and 71.4% whereas that of PAC was found to be 68.93% and 76.75% for cadmium and chromium removal respectively. When initial concentration of cadmium is below 4.5 mg/L, the % removal is found to be more than 68 and when the initial concentration of chromium is below 0.55 mg/L the % removal is more than 69. Best results were obtained when the adsorbents doses are 40 mg/50 mL for removal of cadmium as well as chromium. The results obtained by OPAC and PAC are comparable and OPAC can be used almost at par with PAC.

INTRODUCTION

Cadmium is finding wide use in (i) plating of steel, Fe, Cu, brass and other alloys to protect them from corrosion (ii) producing pigments such as cadmium yellow and cadmium orange (iii) stabilizing plastics(PVC) and rubber (iv) manufacture of air-craft ⁽¹⁾ The most serious chronic effect of cadmium is renal toxicity. Dietary intake of cadmium has also been implicated in osteo-malacia, osteo- porosis and spontaneous fractures conditions, collectively termed "itai-itai" (ouch-ouch) disease and originally documented in post-menopausal women in cadmium contaminated areas of Japan. ⁽²⁾ Cadmium is more efficiently absorbed from the lungs than from the gastrointestinal tract. The absorption efficiency is a function of the specific cadmium compound as well as its exposure concentration and route. Cadmium is transported in the blood by red blood cells and high molecular weight protein such as albumin and accumulates

mostly in kidney and liver. Renal and hepatic toxicity may occur if toxic cadmium levels are in these organs occur even during sub chronic exposure ⁽³⁾ Cadmium fumes are found to be carcinogenic and the carcinogenicity slope factor for cadmium inhalation is 6.1 (mg/kg/day)⁻¹ (US EPA, 1991) Hexa-valent chromium is present in the effluents produced during the electroplating, leather tanning, cement, mining dyeing, fertilizer and photography industries and causes severe environmental and public health problems. Hexa-valent chromium has been reported to be toxic and is also known as carcinogenic as determined by National Toxicology Program (NTP) and U S Environmental Protection Agency. Trivalent chromium has not been shown to be carcinogenic to animals or humans by the oral route.(IARC,1990 , US EPA 1998 , ASTDR 1993 and 1998) ⁽⁴⁾ Hexa-valent chromium is more toxic than trivalent form because its oxidizing potential is high. It easily penetrates biological membranes. Hexa-valent

chromium is unstable and can be reduced to trivalent chromium by many oxidizing agents. Metallic and acidic Hexa-valent chromates and dichromates tend to be strong oxidizing agents. Strong oxidizing agents can cause damage to DNA and many other tissue structures. When administered via inhalation at high doses have the potentiality to induce lung tumors in humans. At higher concentration Hexa-valent chromium is associated with abnormal enzyme activities, altered blood chemistry, lowered resistance to pathogenic organics, etc⁽⁵⁾.

Adsorption is one of the successful techniques of removal of cadmium and chromium from the waste waters ⁽⁶⁾ The tolerance limit for the Cd(II) and Cr (VI) for inland surface waters are 3 mg/L and 0.25 mg/L respectively. A wide range of adsorbents including activated carbons, clays, bentonite, fly ash, Alumina, magnesium oxide, ferric oxide, silica, saw dust, zeolite are used in wastewater treatment.⁽⁷⁾

In the present investigation an attempt is made to produce activated carbon at different temperatures from waste orange peels in the laboratory. The orange peels activated carbon (OPAC) has been used for the removal Cd(II) and Cr(VI) from the waste-water. The results have been compared with commercially available carbon (CAC) in powdered form.

MATERIALS & METHODS

Orange peels were collected directly from food processing industries and they were then naturally dried for 15 days. The dried orange peels were washed with doubled distilled water and again dried in oven for 30 minutes at 105⁰C.

The same were crushed in the grinder and converted into the powder form of uniform size by sieving. This powder of orange-peels was dehydrated in the oven at 105⁰C and the material then was carbonized for 30 minutes in the muffle furnace. The carbonized material was

then impregnated with zinc chloride with a ratio of 1.33 to carbonized char.

The material was then activated at different temperatures viz. 400⁰C to 700⁰C. The product was washed with distilled water to remove acidity and chlorides. The product was then dried. The orange peels activated carbon thus was prepared in the laboratory.

The batch experiments were carried out in the Environmental Engineering laboratory of B V M Engineering College and the metals estimation was made in the Inductively Coupled Plasma (ICP) of Sophisticated Instrumentation Centre for Applied Research & Testing (SICART), Vallabh Vidyanagar. SICART is approved by Department of Science & Technology, Government of India, New Delhi.

Stock solution for cadmium and chromium were prepared in accordance with the guidelines given by Standard Methods- 20th edition. Different concentration of cadmium prepared were 2.5 mg/L, 3.5 mg/L, 4.5 mg/L and 5.5 mg/L. Similarly the chromium concentrations of 0.35 mg/L, 0.55 mg/L and 0.75 mg/L were prepared.

The experiments were performed with different dosages, contact time and initial concentrations of metals with both OPAC and PAC. The results have been reported in Fig 1 to Fig 3.

RESULTS AND DISCUSSIONS

Effect of Contact Time

Effect of contact time was studied by taking initial cadmium concentration of 2.5 mg/L. The optimum dosages of agro based adsorbent OPAC prepared at 600⁰C were used for contact time of 5 min to 45 min. The initial concentration of Chromium used is 0.35 mg/L. It was observed that the rate of uptake of both the metals was higher and reached a steady value after reaching the equilibrium after 45 min in case of cadmium and 30 min in a case of

chromium. The increase in removal efficiency with contact time is due to the increase in surface area and hence more active sites are available for the adsorption.

Effect of Adsorbent Dosage Level

The effect of dosage of OPAC prepared at 600°C and PAC on sorption of both the metals is shown in Fig.2 Study was carried out by taking 2.5 mg/L cadmium solution and 0.35 mg/L of chromium solution. The dosages used both for OPAC and PAC was 20 mg/50mL to 50 mg/50mL. The studies were conducted for optimum contact time. It can be seen from the Fig.2 that the percentage removal increases as the dosages of the OPAC and PAC increase. The % removal using OPAC is found to be 58.54 to 65.44 whereas % removal using PAC show better results viz. 56.93 to 68.94 in removing cadmium. The % removal of chromium with OPAC is ranging 62.55 to 71.4 whereas with PAC it ranges between 69.23 to 76.75.

Effect of Initial Concentration of Metals

The results obtained in Fig 3 show that at lower initial concentration of toxic metals, the removal efficiency is higher (64.28 % to 68.85%) The removal efficiency decreases when cadmium and chromium concentration are increased beyond 4.5 mg/L and 0.55 mg/L.

CONCLUSION

The present study shows that waste banana peels may be used as adsorbent for removal of cadmium and chromium from the wastewater. When initial concentration of cadmium is below 4.5 mg/L, the % removal is found to be more than 68 and when the initial concentration of chromium is below 0.55 mg/L the % removal is more than 69. Best results were obtained when the adsorbents doses are 40 mg/50 mL for removal of cadmium as well as chromium. The results obtained by OPAC and PAC are

comparable and OPAC can be used almost at par with PAC.

REFERENCES

1. Chauhan S S , Khatik S K and P R Dixit , “ Cadmium : A Pollutant Element” Jr. of Industrial Pollution Control 20(2) 2004 pp 235-246
2. Robert A Young, “ Chemical Hazard Evaluation And Communication Group Bio Medical And Environmental Information Analysis Section, Health & Safety Research Division S Department Of Energy, USA Pp 3
3. A S T D R (Agency For Toxic Substances And Disease Registry), “Toxicological Profile For Cadmium” U S Public Health Service Astdr/Tp-88/O8
4. Public Health Goal for Chromium In Drinking Water, Office Of Environmental Health Hazard Assessment, California Environmental Protection Agency Feb (1999) Pp 1-3
5. Environmental Contaminants Encyclopedia: Chromium (VI) Entry, National Park Service, Water Resources Divisions, Colorado 1997 Pp-6
6. Rao M , Parwate AV and Thakare SB, “ Adsorption Studies For The Removal Of Organics And Heavy Metals Using Low Cost Materials-A Critical Review” Environmental Pollution Control Journal , Vol 6 No.2 Jan-Feb 2003
7. Rathi A K and Puranik S A, “Chemical Industry Wastewater Treatment Using Adsorption” Journal Of Scientific & Industrial Research, Vol 61,January 2002 pp 53-60.

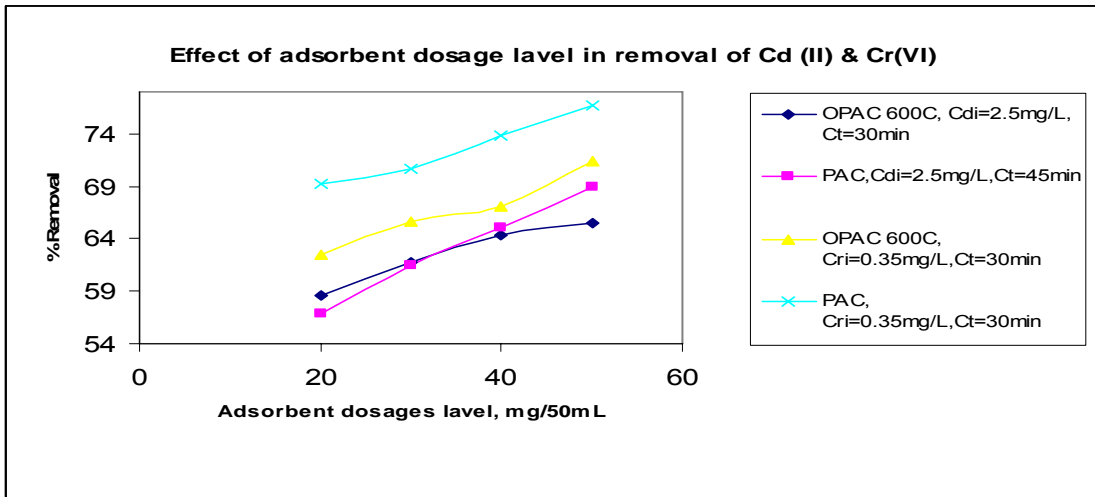

Figure - 1

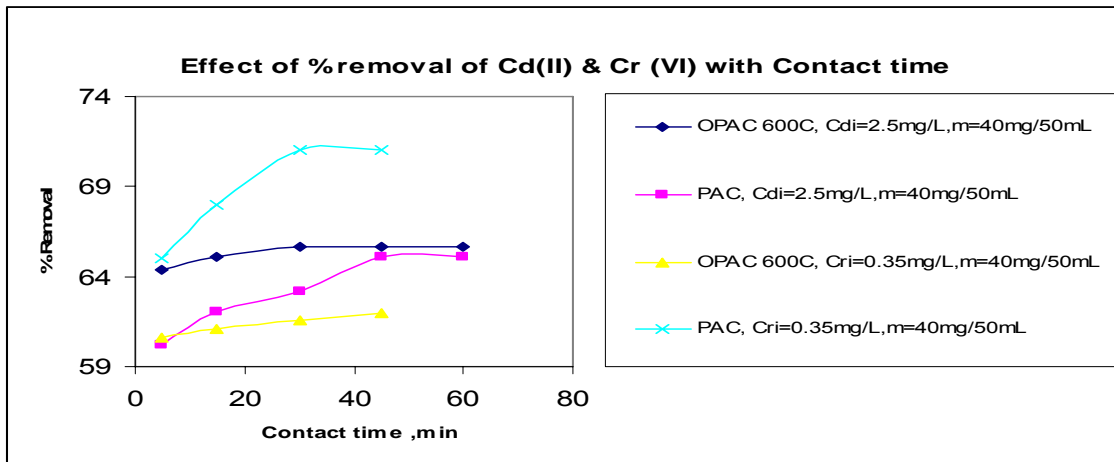

Figure - 2

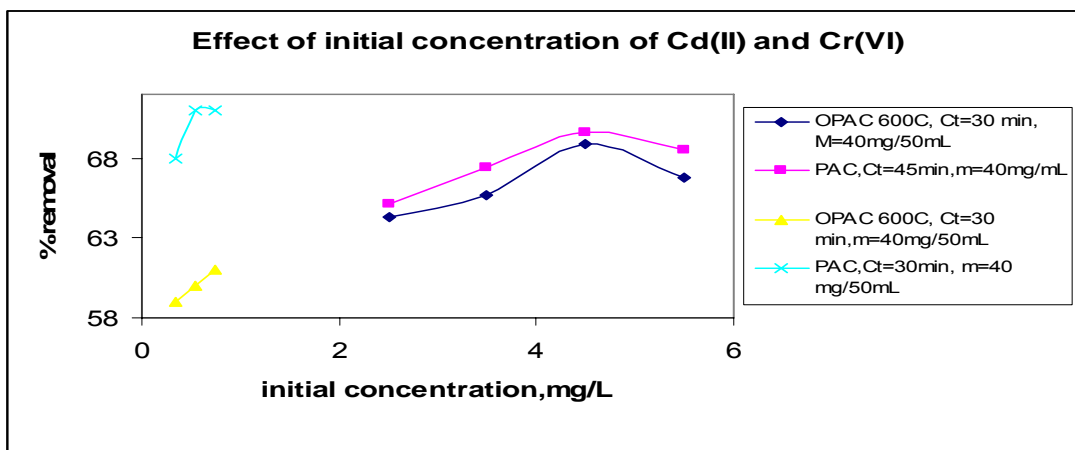

Figure - 3

APPLICATION OF PCA IN FACE RECOGNITION AND PERFORMANCE OF PCA BASED FRS SYSTEM.

Mehfuza Holia

Lecturer
Electronics Department
BVM Engineering College, VV Nagar

Vinay Thumar

Senior lecturer
Electronics Department
DDIT, Nadiad

ABSTRACT

In recent years considerable progress has been made in area of face recognition through the development of techniques like eigenfaces, computers can compute favourably with humans in many face recognition task particularly those in which large database of faces must be searched. Images containing faces are essential to intelligent vision-based human computer interaction and research efforts in face processing include face recognition, face tracking, and pose estimation. To build fully automated systems that analyze the information contained in face images, robust and efficient face recognition algorithms are required.

Principal component analysis, based on information theory concepts, seek a computational model that best describes a face, by extracting the most relevant information contained in that face. Goal is to find out the eigenvectors (eigenfaces) of the covariance matrix of the distribution, spanned by a training set of face images. Later, every face image is represented by a linear combination of these eigenvectors. Evaluations of these eigenvectors are quite difficult for typical image sizes but, an approximation that is suitable for practical purposes is also presented. Recognition is performed to give maximum success rate. Performance of PCA on different databases is observed and evaluated.

1. Introduction

Principal Component: A set of variable that define a projection that encapsulates the maximum amount of variation in a dataset.

PCA is a useful statistical technique that has found application in. fields such as face recognition and image compression, and is a common technique for finding patterns in data of high dimension. PCA is a method that reduces data dimensionality by performing a covariance analysis between factors. As such, it is suitable for data sets in multiple dimensions. In FRS, PCA is applied to find the aspects of face which are important for identification. The other jobs or functions which PCA technique

can do are prediction, redundancy removal, feature extraction etc. Because PCA is a classical technique which can do something in the linear domain, applications having linear models are suitable, such as signal processing, image processing, system and control theory, communications, etc. The purpose of PCA is to reduce the large dimensionality of the data space (observed variables) to the smaller intrinsic dimensionality of feature space (independent variables), which are needed to describe the data economically. This is the case when there is a strong correlation between observed variables [6]. The main idea of using PCA for face recognition is to express the large 1-D vector of pixels constructed from 2-D facial image into the

compact principal components of the feature space. This can be called eigenspace projection. Eigenspace is calculated by identifying the eigenvectors of the covariance matrix derived from a set of facial images (vectors). FRS (Face Recognition system) has main six functional blocks.

1. **Acquisition module:** In this module the face image under consideration is presented to the system.

2. **Pre-processing module:** Here image size normalization, histogram equalization, median filtering, high-pass filtering, background removal, translation and rotation normalization, illumination normalization etc can be applied according to requirement.

3. **Feature extraction module:** This module finds the key features that are going to be used for classification.

4. **Classification Module :** In this module, extracted features of the image are going to be used for classification.

5. **Training Set :** Feature extraction and the classification modules adjust their parameters in order to achieve optimum recognition performance by making use of training sets.

6. **Face library or Face database :** Face library or face database consists of face images for comparisons

1.1 PCA based approach for face recognition:

Here the method proposed by M.Turk and A.Pentlad [1] is used with some modification.

The algorithm involves the following steps.

1. Form a face library that consists of the face images of known individuals.

2. Choose a training set that includes a number of images (T) for each person with some variation in expression and in the

lighting. Here training set consists of face images I_1, I_2, \dots, I_T .

3. Represent every image I_i as a vector Γ_i such that each image is represented as a vector, such that 200 x 180 image is represented as 36,000 x 1.

4. Normalize the face image is preprocessing task to avoid strong or weak illumination. Image normalization refers to eliminating image variations (such as noise, illumination, or occlusion) that are related to conditions of image acquisition and are irrelevant to object identity. Here the mean value of image is subtracted from each pixel.

If ψ_i is a mean value of image I_i , then Normalized image $\Phi_i = \Gamma_i - \psi_i \dots \dots \dots (1)$

5. Compute the covariance matrix C

$$C = \frac{1}{T} \sum_{k=1}^T \Phi_k \Phi_k^T = A A^T \dots \dots \dots (2)$$

Where $\Phi_i = \Gamma_i - \psi_i \dots \dots \dots (3)$

For $T = 36$, we are having matrix $A = [\Phi_1, \Phi_2, \dots, \Phi_T]$. which is of 36,000 x 36, in which each image is represented as a one vector (36,000 x 1). So we will get the covariance matrix C of size 36 x 36.

6. Find eigen vectors u_i and eigen values μ_i for covariance matrix such that $Cu_i = \mu_i u_i$ and plot the eigen faces. Covariance matrix is of 36 x 36 and we will get eigen vector of 36 x 36 and eigen values of 1x36. These eigenvectors can be thought of as a set of features that together characterize the variation between face images. Each image location contributes more or less to each eigenvector, so that it is possible to display these eigenvectors as a sort of ghostly face image which is called an "eigenface". Eigenfaces can be viewed as a sort of map of the variations between faces.

7. After finding eigenvectors and eigenvalues, eliminate those vectors whose eigen value are zero and normalize all eigenvectors.

8. Find the weight of each face in training set. The weights form a feature vector

$$\Omega_i^T = [w_1, w_2, \dots, w_T] \dots\dots\dots(4)$$

$$\text{Where } w_k = u_k^T \Phi_i \dots\dots\dots(5)$$

Where $k = 1, 2, 3, \dots, T$, that describes the contribution of each eigenface to the face images in training set. For $T=36$, we will get the Ω^T which is of 36×36 .

9. Given an unknown face image Γ (centered and of the same size like the training faces) is normalized, $\frac{\Gamma - \psi}{\sigma}$ where ψ is the average face vector of all images in training set.

10. A new face image (Γ) is transformed into its eigenface components by a simple operation,

$$W_k = u_k^T (\Gamma - \psi) \text{ , Where } k = 1, 2, \dots, T$$

11. A face image can be approximately reconstructed (rebuilt) by using its feature vector and the eigenfaces as $\Gamma' = \psi + \Phi_r$ $\dots\dots\dots(6)$

$$\text{Where } \Phi_r = \sum_{i=1}^T w_i u_i \dots\dots\dots(7)$$

12. The degree of the fit can be expressed by means of the Euclidean distance between the original and the reconstructed face image as given as

$$\varepsilon = \|\Phi - \Phi_r\| \dots\dots\dots(8)$$

A given image is classified as face when the minimum ε is below some chosen threshold θ_ε , otherwise the image is not a face.

13. The Euclidean distance of the weight vector of the new image from the face class weight vector can be calculated as follows

$$\varepsilon_k = \|\Omega - \Omega_k\| \dots\dots\dots(9)$$

where Ω_k is a vector describing the k th face class. The face class Ω_i are calculated by averaging the result of the eigenface representation over a small

number of face images (as few as one) of each individual. A face is classified as belonging to class k when the minimum ε_k is below some chosen threshold θ_ε , otherwise the face is classified as "unknown" and optionally used to create a new face class.

14. Find threshold θ_f (the threshold to decide whether given image is face or not) and threshold θ_ε (the threshold to decide whether given face image is known or unknown).

To find θ_ε , first find minimum ε_k (step 13), and to find θ_f , first find ε (step 12). For deciding thresholds, We have taken different training sets, different input images which are known or unknown face or non face images and for all we have found ε_k and ε .

2. Evaluation & Results:

2.1 Experiment 1

In Experiment 1, Face database is taken from University of Essex, UK (Designed by Dr. Libor Spacek) at <http://www.essex.ac.uk/face94.html>.

Here images are taken with variation in facial expression open/closed eyes, smiling/not smiling. There is not much variation in orientation. Algorithm described in 1.1 is implemented in matlab. Figure 1 shows 13 different individual's colour face images of $200 \times 180 \times 3$ images. These images are converted in gray format as 200×180 .

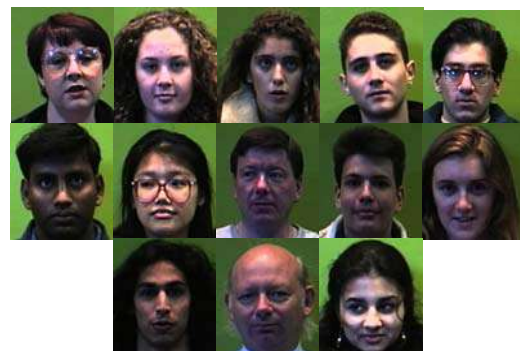

Figure 1

Thirteen Individual's of Face Database

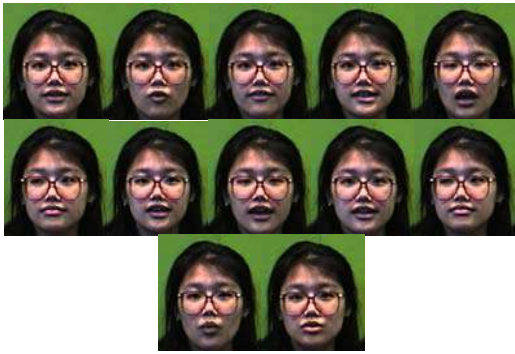

Figure 2

Different Posed Face Image of Single Individual



Figure 3
Face database for T=36
(Matlab Figure)

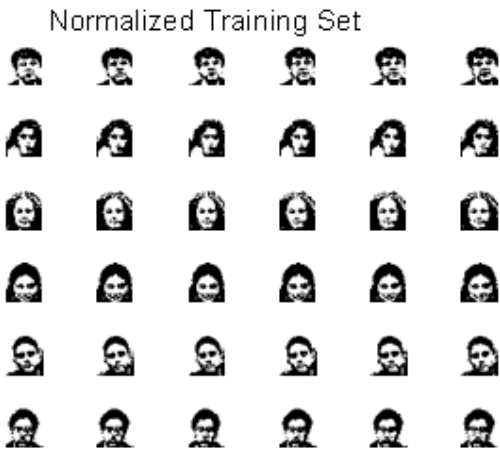

Figure 4
Normalized training set



Figure 5 Eigenfaces for T=36

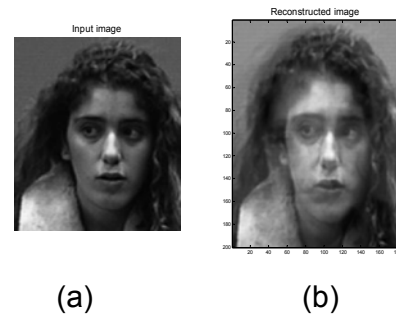

Figure 6 (a) input image (known)
(b) Reconstructed image

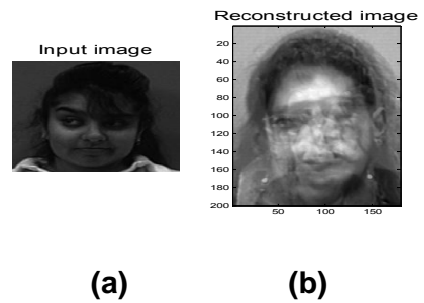

Figure 7 (a) input image (unknown)
(b) Reconstructed image

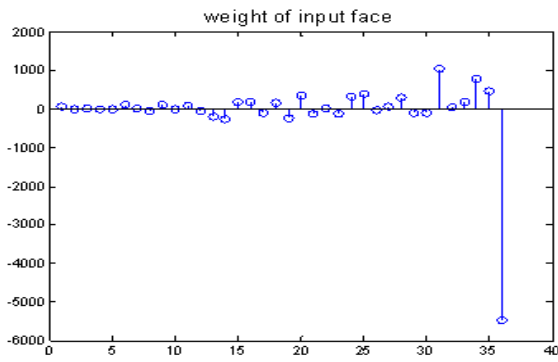

Figure 8 The weights (of input image(unknown) of different eigen faces)

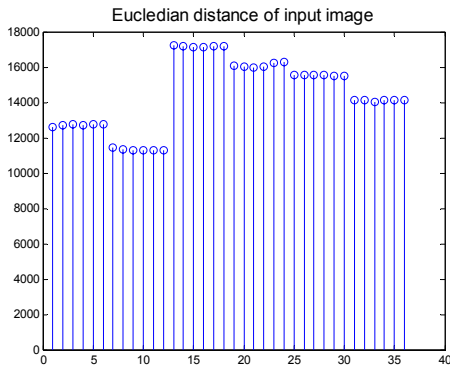
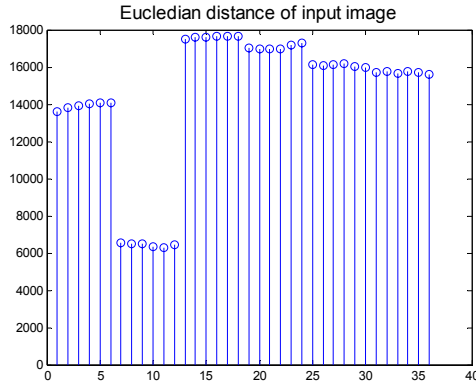

Figure 9 :

- (a) Euclidean distance of input image(known face)**
- (b) Euclidean distance of input image(unknown face)**

We have taken Euclidean distances for more than 70 images and we have decided the threshold which gives me maximum success rate.

After observing the ϵ_k for different images, We have decided threshold θ_ϵ

(the threshold to decide whether given face image is known or unknown).such that which gives me maximum success rate.

$$4500 < \epsilon_k < 7500 .$$

After observing the ϵ for different images, we have decided threshold θ_f (the threshold to decide whether given image is face or not).such that which gives me maximum success rate.

$$6.0 \times 10^3 < \epsilon < 9.45 \times 10^3 .$$

No. of images in training set	Number of input image included in the training set	Recognition Rate	
		Image as a face	Known face
T=36	6	100 %	100 %
T=42	6	100 %	100 %
T=48	6	100 %	100 %
T=60	6	100 %	100 %
T=66	6	100 %	100 %
T=72	6	100 %	100 %
T=78	6	100 %	100 %

Table 1 Performance of the FRS for the known input Images

No. of images in training set	Number of input images included in the training set	Recognition Rate	
		Image as a face	Unknown face
T=36	0	100 %	100 %
T=42	0	100 %	100 %
T=48	0	100 %	100 %
T=60	0	100 %	100 %
T=66	0	90 %	100 %
T=72	0	90 %	100 %
T=78	0	80 %	90 %

Table 2 Result for the FRS for the unknown input images

Number of images in training set	Number of input image included in the training set	Recognition Rate	
		Image as a face	Known face
T=36	1	100 %	100 %
	2	100 %	100 %
	3	100 %	100 %
	4	100 %	100 %
	5	100 %	100 %
	6	100 %	100 %
T= 42	1	100 %	100 %
	2	100 %	100 %
	3	100 %	100 %
	4	100 %	100 %
	5	100 %	100 %
	6	100 %	100 %
T=48	1	100 %	100 %
	2	100 %	100 %
	3	100 %	100 %
	4	100 %	100 %
	5	100 %	100 %
	6	100 %	100 %
T=54	1	100 %	100 %
	2	100 %	100 %
	3	100 %	100 %
	4	100 %	100 %
	5	100 %	100 %
	6	100 %	100 %
T=60	1	100 %	100 %
	2	100 %	100 %
	3	100 %	100 %
	4	100 %	100 %
	5	100 %	100 %
	6	100 %	100 %
T=66	1	100 %	100 %
	2	100 %	100 %
	3	100 %	100 %
	4	100 %	100 %
	5	100 %	100 %
	6	100 %	100 %
T=72	1	100 %	100 %
	2	100 %	100 %
	3	100 %	100 %
	4	100 %	100 %
	5	90 %	100 %
	6	100 %	100 %
T=78	1	100 %	100 %
	2	80 %	80 %
	3	80 %	90 %
	4	80 %	80 %
	5	100 %	100 %
	6	100 %	100 %

Table 3 Performance of the FRS for the different number of known input images.

2.2 Experiment 2

In experiment 2, the database with different lighting condition, different expression and Different orientations are taken. Here the images are taken from Indian Face Database created by IIT Kanpur students. This data face can be downloaded from [http://vis-](http://vis-www.cs.umass.edu/~vidit/IndianFaceDatabase/)

[www.cs.umass.edu/~vidit/IndianFaceDatabase/](http://vis-www.cs.umass.edu/~vidit/IndianFaceDatabase/).



Figure 10 Different Posed Face Image of Single Individual



Figure 11 Training set of T = 36 with different Lighting condition, orientation and expression.

In experiment 2, the threshold values are found using methods given in step 14. Threshold values are taken as

- (I) $7000 < \epsilon_k < 8900$
 (II) $1.0 \times 10^3 < \epsilon < 1.4 \times 10^3$

No. of images in training set	Number of input image included in the training set	Recognition Rate	
		Image as a face	Known face
T=36	6	100 %	100 %
T=42	6	100 %	100 %
T=48	6	100 %	100 %
T=60	6	100 %	100 %
T=66	6	100 %	100 %
T=72	6	100 %	100 %
T=78	6	100 %	100 %

Table 4 Result for the FRS for the known input images with variation in expression, lighting condition but without variation in head orientation.

No. of images in training set	Number of input image included in the training set	Recognition Rate	
		Image as a face	Known face
T=36	6	100 %	90 %
T=42	6	100 %	90 %
T=48	6	100 %	90 %
T=60	6	100 %	80 %
T=66	6	100 %	80 %
T=72	6	100 %	90 %
T=78	6	100 %	90 %

Conclusion:

Table 5 Result for the FRS for the known input images with variation in expression, lighting condition and variation in head orientation.

1. Eigenfaces approach is superior in its speed and reasonably simple implementation. It is seen that the evaluation of a feature vector involves merely additions and during the experiments, although no special hardware was used.

2. From Experiment 1 and Experiment 2, it is proved that if input image (known image) which is given for recognition is

having slight variation in expression such as open/closed eyes, smiling/not smiling than training set, and then the face recognition rate is 100%. This is shown in Table 1 and Table 4.

3. For the input image (known image) which is given for recognition is having variation in expression, lighting condition and head orientation, and the result is averaged then eigenface approach gives 85% correct averaged over orientation variation and 96 % correct averaged over light variation.

4. If the input image (known image) with orientation variation (till 90 degree) is included in face database, then it gives 100% result over orientation variation.

REFERENCES:

1. Matthew A. Turk And Alex P. Pentland, "Face Recognition using Eigenfaces", Vision and Modeling Group, the Media Laboratory, Massachusetts Institute Of Technology, IEEE.

2. R.Chellappa,C.wilson and S.Sizohey "Human and machine recognition of faces: A survey preceding of IEEE, Vol .83 May 98.

3. Ming-Hsuan Yang, Member, IEEE, David J. Kriegman, Senior Member, IEEE And Narendra Ahuja, Fellow, IEEE, "Detecting faces in Images: A survey", IEEE transactions on pattern analysis and machine intelligence, Vol.24, No.1, January 2002.

4.Sirovich, L. and Kirby, "Low dimensional procedure for the characterization of human faces", M, Journal of the Optical Society of America A, 4(3), 519-524.

5. Xiaoguang Lu "Image Analysis for Face recognition" ,Dept. of computer Science & Engineering, Michigan State University, East Lansing MI,48824.

6."A tutorial on Principal Component Analysis" by Lindsay I Smith.

7."Real time face recognition using Eigen faces" by Raphel Cendrillon Brian .C. Lovell.

8. M. Turk and A. Pentland, "Eigenfaces for recognition" Journal of Cognitive Neuroscience, vol.3.

9. W. Zhao, R. Chellappa, A. Rosenfeld, and J. Phillips, "Face Recognition: A Literature Survey". ACM Computing Surveys, Vol. 35, No. 4, December 2003, pp. 399–458.

10."Eigen-Faces And Face's Discrimination" by Luis Janez Escalada.

11."The CSU Face Identification Evaluation System User's Guide: Version 5.0" Ross Beveridge, David Bolme, Marcio Teixeira and Bruce Draper Computer Science Department Colorado State University May 1, 2003.

12."Principal Component Analysis"
<http://www.ucl.ac.uk/oncology/MicroCore/>

13."Principal Components and Factor Analysis"
"http://www.statsoft.com/textbook/stfacan.htm

14. Evgeniy Bart and Shimon Ullman "Image normalization by mutual information" Dept. of Computer Science and Applied Mathematics Weizmann Institute of Science Rehovot, Israel 76100.

15.Jian Yang David Zhang Biometrics Centre, "Is ICA Significantly Better than PCA for Face Recognition?" Department of Computing, Hong Kong Polytechnic University, Kowloon, Hong Kong.

16."Digital Image Processing", R Gonzalez and R Wood Prentice Hall, 2002

17. University of Essex, UK(Designed by Dr. Libor Spacek) at
<http://www.essex.ac.uk/face94.html>.

18. Indian Database
<http://viswww.cs.umass.edu/~vidit/IndianFaceDatabase>.

A COMPARATIVE ANALYSIS OF TRAVELLING SALESMAN PROBLEM USING VECTORED EVALUATED GENETIC ALGORITHM AND NICHED PARETO GENETIC ALGORITHM METHODS

Kinjal U. Adhvaryu

Lecturer,
Computer Engineering Department
Gandhinagar Institute of Technology,
Ta.-Kalol, Dist.- Gandhinagar

ABSTRACT

Evolutionary Algorithms (EAs) are often well suited for optimization problems involving several coupled parameters objectives. Since 1985, various evolutionary approaches to multiobjective optimization have been developed, capable of searching for multiple solutions in a single iteration. These methods differ in the fitness assignment function obtained, however the decision to which method is best suited for a given problem depends mainly upon the nature of problem and its complexity. As most of the real time applications This paper utilize the multiobjective EAs which makes multiobjective EA as a technique for different applications. This paper utilize two multiobjective EAs : Vektored Evaluated Genetic Algorithm (VEGA), Niched Pareto Genetic Algorithm (NPGA) and compared the results with the multiobjective Traveling Salesman Problem (MOTSP). And concluded that NPGA algorithm is comparatively best suited for any TSP type transportation applications.

Keywords: Genetic algorithms, search, optimization, optimal control, stochastic process, multimodal problems, multiobjective problems.

1. INTRODUCTION

The Traveling Salesman Problem (TSP) is one which has commanded much attention of mathematicians and computer scientists specifically because it is so easy to describe and so difficult to solve. The problem can simply be stated as: if a traveling salesman wishes to visit exactly once each of a list of m cities and then return to the home city, what is the least costly tour the traveling salesman can take? And the Multi-objective traveling salesman problem (MOTSP) is one in which a traveling salesman wishes to visit exactly once each of a list of m cities and then return to the home city but with more than one constraint like minimize distance, cost, time or increase

touring attractiveness etc. Here the problem is symmetric multi-objective traveling salesman problem.

Much of the work on the MOTSP is not motivated by direct applications, but rather by the fact that the MOTSP provides an ideal platform for the study of general methods that can be applied to a wide range of discrete optimization problems. This is not to say, however, that the MOTSP does not find applications in many fields. Indeed, the numerous direct applications of the MOTSP bring life to the research area and help to direct future work.

Different multi-objective genetic algorithm methods [2,7] have been proposed by the

researchers and have been used for multi-objective optimization for number of years. Yet, in general, no method is superior to all others in all the performance aspects. Different methods have their advantages and disadvantages. But still there is a scope for finding out which method is appropriate for particular Multi-objective Traveling Salesman Problem. A comparative analysis of these methods is a new research area. The methods are mainly compared on the basis of diversity of solutions and closeness to the Pareto front. This paper takes up different multi-objective genetic algorithms and compares their performance by applying them to a Multi-objective Traveling Salesman problem. Hence this project explores the performance of different MOEAs.

2. GENETIC ALGORITHM

Since the idea of genetic algorithms was introduced by John Holland. GAs has been applied to a lot of optimization problems. Search and optimization techniques can be categorized into three classes: calculus based, enumerative, and random. Calculus based approaches usually require the existence of derivatives and the continuity. Therefore it is difficult to apply them to realistic problems where these assumptions often do not hold. Enumerative methods are straightforward search schemes. They can be applied to optimization problems when the number of feasible solutions is small. Most optimization problems in the real world, however, have countless possible solutions. Therefore they cannot be applied to such complex problems. As for random searches, while they search in solution spaces without any kind of information, it may not be efficient. Therefore the search direction should be specified in order to improve their search ability. GAs is one of random searches because they use a random choice as a tool in their searching process. While a random choice performs an important role in GAs, the environment directs the search in GAs. That is, they utilize

information from the environment in their searching process.

Differences between Genetic Algorithms and Traditional Methods

The Genetic Algorithms differ with traditional methods in the following ways:

1. Genetic algorithms work with a coded form of the function values (parameter set), rather than with the actual values themselves.
2. Genetic algorithms use a set, or population, of points to conduct a search, not just a single point on the problem space. This gives Genetic Algorithms the power to search noisy spaces littered with local optimum points. Instead of relying on a single point to search through the space, the Genetic Algorithms looks at many different areas of the problem space at once, and uses all of this information to guide it.
3. Genetic Algorithms use only payoff information to guide themselves through the problem space. Many search techniques need a variety of information to guide them. The only information a Genetic Algorithm needs is some measure of fitness about a point in the space. Once the Genetic Algorithm knows the current measure of "goodness" about a point, it can use this to continue searching for the optimum.
4. Genetic Algorithms are probabilistic in nature, not deterministic. This is a direct result of the randomization techniques used by Genetic Algorithms.
5. Genetic Algorithms are inherently parallel. Here lies one of the most powerful features of genetic algorithms. Genetic Algorithms, by their nature, are very parallel, dealing with a large number of points (strings) simultaneously.

3. MULTI-OBJECTIVE OPTIMIZATION PROBLEMS

Besides having multiple objectives, there are a number of fundamental differences between single-objective and multi-objective optimization as follows:

- 1) Two goals instead of one;
- 2) Dealing with two search spaces;
- 3) No artificial fix-ups.

A striking difference between a classical search and optimization method [2, 3] and a Genetic Algorithm is that in the latter a population of solutions is processed in each iteration (or generation). This feature alone gives Genetic Algorithms a tremendous advantage for its use in solving multi-objective optimization problems. Recall that one of the goals of an ideal multi-objective optimization procedure is to find as many Pareto-optimal solutions as possible. Since a Genetic Algorithm works with a population of solutions, in theory we should be able to make some changes to the basic Genetic Algorithm so that a population of Pareto-optimal solutions can be captured in one single simulation run of a Genetic Algorithm. This is the powerful feature of Genetic Algorithms that makes them particularly suitable to solve multiobjective optimization problems. We don't need to perform a series of separate runs as in the case of the traditional mathematical programming techniques.

The first real implementation of a multi-objective genetic algorithm (vector valued GA or VEGA) was suggested by David Schaffer in 1984. The name VEGA is appropriate for multi-objective optimization, because his GA evaluated an objective vector (instead of a scalar objective function), with each element of the vector representing each objective function. Although VEGA is simple to implement, it does not find diverse solutions in the population and converges to individual champion solutions only. Surprisingly, no significant study was performed for almost a decade after the

pioneering work of Schaffer. Thereafter, several independent groups of researchers have developed different versions of multi-objective evolutionary algorithms [2, 3, 4]. Some of them are:

- i) Multi-objective GA (MOGA) by Fonseca and Fleming (1993)
- ii) Non-dominated Sorting Genetic Algorithms (NSGA) by Srinivas and Deb (1994)
- iii) Niche-Pareto Genetic Algorithm (NPGA) by Horn, Nafploitis and Goldberg (1994).

3.1 Vector Evaluated Genetic Algorithm (VEGA)

VEGA is the simplest possible multi-objective Genetic Algorithm [2] and is a straightforward extension of a single-objective Genetic Algorithm for multi-objective optimization. Since a number of objectives (say M) have to be handled, Schaffer thought of dividing the population at every generation into M equal subpopulations randomly. Each subpopulation is assigned a fitness based on a different objective function. In this way, each of the M objective functions is used to evaluate some members in the population. The population at any generation is divided into M equal divisions. Each individual in the first subpopulation is assigned a fitness based on the first objective function only, while each individual in the second subpopulation is assigned a fitness based on the second objective function only, and so on.

VEGA procedure

1. Set an objective function counter $i = 1$ and define $q = N/M$.
2. For all solutions $j = 1 + (i - 1) * q$ to $j = i * q$, assign fitness as $F(x^{(j)}) = f_i(x^{(j)})$.
3. Perform proportionate selection on all q solutions to create a mating pool P_i .

4. If $i = M$, go to step 5. Otherwise, increment i by one and go to step 2.

5. Combine all mating pools together so that $P = P1U P2U \dots U PM$. Perform crossover and mutation on P to create a new population

3.2 Niched Pareto Genetic Algorithm (NPGA)

Horn and Nafploitis proposed a tournament selection scheme based on Pareto dominance [2,4]. Instead of limiting the comparison to two individuals, a number of other individuals in the population were used to help determine dominance (typically around 10). When both competitors were either dominated or non-dominated (i.e., there was a tie), the result of the tournament was decided through fitness sharing. Population sizes considerably larger than usual with other approaches were used so that the emerging niches in the population could tolerate the noise of the selection method.

NPGA Tournament Selection Procedure

Arguments – i, j, Q .

Returns – winner

1. Pick a sub-population T_{ij} of size t_{dom} from the parent population P .

2. Find α_i as the number of solutions in T_{ij} that dominated i . Calculate α_j as the number of solutions in T_{ij} that dominates j .

3. If $\alpha_i = 0$ and $\alpha_j > 0$, then i is the winner. The process is complete.

4. Otherwise, if $\alpha_i > 0$ and $\alpha_j = 0$, then j is the winner. The process is complete.

5. Otherwise, if $|Q| < 2$, i or j is chosen as a winner with probability 0.5. The process is complete. Alternatively, the niche counts nc_i and nc_j are calculated by placing i and j in the current offspring

population Q , independently. With the niching parameter σ_{share} , nc_i is calculated as the number of offspring ($k \in Q$) within a σ_{share} distance d_{ik} from i . The distance d_{ik} is the Euclidean distance between solutions i and k in the objective space.

6. If $nc_i \leq nc_j$, solution i is the winner. Otherwise, solution j is the winner.

NPGA Procedure

1. Shuffle P , set $i = 1$, and set $Q = \phi$.

2. Perform the above tournament selection and find the first parent, $p1 = \text{NPGA-tournament}(i, i + 1, Q)$.

3. Set $i = i + 2$ and find the second parent, $p2 = \text{NPGA-tournament}(i, i + 1, Q)$.

4. Perform crossover with $p1$ and $p2$ and create offspring $c1$ and $c2$. Perform mutation on $c1$ and $c2$.

5. Update offspring population $Q = Q \cup \{c1, c2\}$.

6. Set $i = i + 1$. If $i < N$, go to step 2. Otherwise, if $|Q| = N / 2$, shuffle P , set $i = 1$, and go to step 2. Otherwise, the process is complete.

4. PERFORMANCE COMPARISON

In the following, the case study is described that has been carried out using the above four multiobjective EAs for solving an extended Multiobjective Traveling Salesman Problem. There are two distinct goals in multi-objective optimization: (1) discover solutions as close to the Pareto-optimal solutions as possible, and (2) find solutions as diverse as possible in the obtained non-dominated front. An MOEA will be termed a good MOEA, if both goals are satisfied adequately. For that Set Coverage Metric and Maximum Spread Metric are used.

4.1 Implementation Details

This work describes implementation of different instances of two different numbers of objectives for Traveling Salesman Problem. All the programs were coded in C. It uses Turbo C in DOS environment. This paper takes 4 instances of each 2 algorithms for bi-objective traveling salesman problem. Also 4 instances of each 2 algorithms for three-objective symmetric traveling salesman problem. In bi-objective TSP, the objectives are to minimize distance and cost. In three-objective TSP, the objectives are to minimize distance and cost and maximize touring attractiveness.

4.2 Simulation for 3-objective TSP

This paper uses the MOTSP with the problem-instances for 10-cities, 25-cities, 50-cities and 60-cities. This analysis work contains total 16 graph for bi-objective TSP and three-objective TSP. Given graphs show that NPGA satisfies both condition to be a good MOGA compared to VEGA. This paper contains solution sets for 25-cities and 60-cities instances for VEGA and NPGA. Results are compared on the basis of performance metrics. There are two distinct goals in multi-objective optimization: 1) Discover solutions as close to the pareto-optimal solutions as much as possible and 2) Find solutions as diverse as possible in the obtained non-dominated front. An MOEA will be termed a good MOEA, if both goals are satisfied adequately. Comparatively NPGA shows good results.

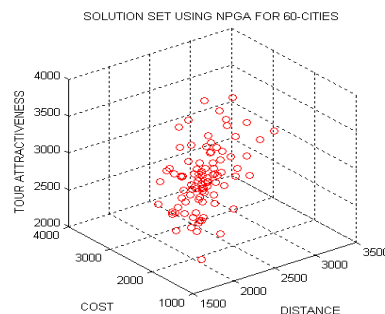
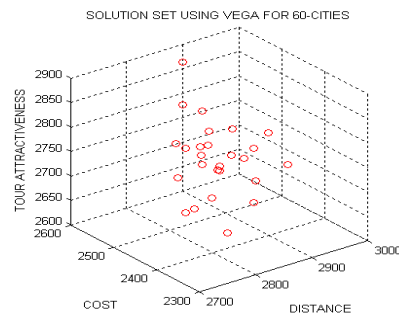
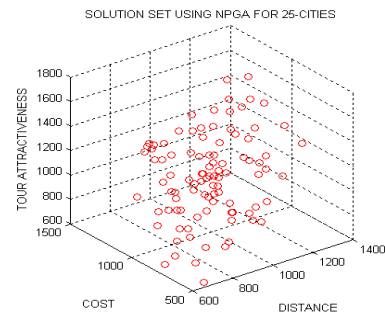
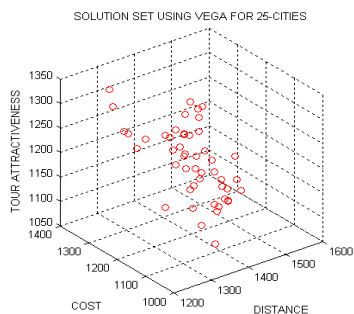

5. CONCLUSIONS

Looking at solution set for 25-cities and 60-cities instances, NPGA gives the good results compared to VEGA. The results of Maximum Spread and Average Set Coverage also show that NPGA is good compare to VEGA since it selects individuals by directly checking them for the non-domination. Also, from solution sets, we can see that NPGA gives more number of solutions compared to VEGA. From different performance metrics it is clear that there is no effect of number of objectives on performance of NPGA. We can also see that as the number of cities increase, the solution sets given by NPGA will be increase compared to VEGA. From all above reasons we can say that NPGA is the best suitable algorithm also for Multi-objective traveling salesman problem.

REFERENCES

- [1] Goldberg, D.E. (1989). Genetic Algorithms in Search, Optimization, and Machine Learning. Singapore: Pearson Education.
- [2] Deb, K. (2002). Multi-objective Optimization using Evolutionary Algorithms. West Sussex: John Wiley and Sons, Ltd.
- [3] Coello, Carlos A. and Christiansen, Alan D. An Approach to Multi-objective Optimization using Genetic Algorithms. Department of Computer Science, Tulane University, New Orleans, LA, USA
- [4] D. S. Johnson and L. A. McGeoch, The Traveling Salesman Problem: A Case Study in Local Optimization, Local Search in Combinatorial Optimization, E. H. L. Aarts and J.K. Lenstra (ed), John Wiley and Sons Ltd, 1997, pp 215-310.
- [5] Chang Wook Ahn. Advances in Evolutionary Algorithms. Theory, Design and Practice, Springer, ISBN 3-540-31758-9, 2006
- [6] Zitzler, E. and Thiele, L. An Evolutionary Algorithm for Multi-objective Optimization: The Strength Pareto Approach. Computer Engineering and Networks Laboratory, Swiss Federal Institute of Technology, Zurich, Switzerland.
- Ajith Abraham, Lakhmi Jain and Robert Goldberg(editors).Evolutionary Multiobjective Optimization. Theoretical Advances and Applications, Springer, USA, 2005, ISBN 1-85233-787-7.

HEAT EXCHANGER NETWORKING FOR THE AMMONIA PLANT USING PINCH TECHNOLOGY*

U. J. Patdiwala

Assistant Professor
Mech. Engg. Dept.
GIT, Kalol, Gandhinagar

S. P. Patel

Assistant Professor
Mechanical Engineering Department
Sardar Vallabhbhai Patel Institute of Technology,
Vasad, Gujarat

P. G. Choksi

Lecturer

ABSTRACT

Pinch technology is a set of conceptual tools and techniques for analyzing and optimizing total energy systems in any process unit. Components of energy systems in process plants include Heat Exchanger Network (HEN), utility system, combined heat and power cycle and heat pumping system which can be designed together by considering entire view involving the interactions among them. Pinch technology is not only used for energy savings but also enhanced operation flexibility and reduced environmental impact. This paper deals with practical application of well known "Pinch Technology".

The initial phase of finding pinch point temperature in this technology is carried out in two different ways: Composite Curve Method which uses graphical analysis method and Problem Table Method which uses an algorithm for setting the targets algebraically.

From the analysis, an optimum Heat Exchanger Networking has been designed for the existing plant, as well as optimum number of heat exchangers and total heat load required for hot and cold streams has been carried out which results in reduction of capital cost and complexity of HEN.

Key words: Pinch, Composite Curve Method, Problem Table method, Maximum Energy Recovery.

NOMENCLATURE

CP heat capacity-flow rates (kW/K)
 ΔH change of flow enthalpy (kW)
 T_s supply temperature of process stream (K)
 T_t target temperature of process stream (K)
 H, HOT relating to hot stream
 $C, COLD$ relating to cold stream

1. INTRODUCTION

Developing the best-integrated process designs for both new plants and retrofits pinch technology has proved to be very effective. This has been demonstrated in numerous successful projects in traditional sectors such as oil refining, petrochemical, fertilizers, general chemical and specialist sectors like food and drink, pulp and paper etc. Recent developments extend the Pinch technology from single processes to total sites, i.e. factories incorporating several processes, serviced by and linked through a central utility system.

In at least half of the new design projects, capital cost implications were saving rather than expenditure in other words, more elegant integration made it possible to identify process that would not only be cheaper to run but also cheaper to build. Benefits of this technology can be

- Energy saving identified ranged from 6% to 60% of the original design.
- Corresponding capital savings were as high as 30% of the original design.
- Payback time in plant modifications was improved by factors up to four.
- The improved designs do not tend to present unusual difficult control and operable problems and indeed some featured better control characteristics than the original designs.

This success is due to two main reasons as the techniques are based on completely new principles and concept, which is simple. The heat recovery “Pinch” is a new thermodynamic concept at the center of the techniques. Following on from the “Pinch” there are many new concepts and techniques. Between them, these concepts and techniques make it possible for the user to deal quickly and confidently with problems so far thought too complex to be properly understood.

2. PRACTICAL THERMODYNAMIC PERFORMANCE TARGET

In most people’s minds, thermodynamics is associated with energy costs and thermodynamic arguments are only practical if capital costs are low. Consider Fig. 1; at the top a heat exchanger network is shown that would seem appropriate to most when energy is cheap but with expensive capital. There is no process heat recover- only utility usage. At the bottom a network is shown which would seem appropriate to most when energy is expensive. There is as much process heat recovery as is possible in preference to utility usage. The implicit assumption is that heat

recovery (instead of utility use) saves energy but costs the capital.

3. APPLICATION OF THE INTEGRATION TECHNIQUES

The initial phase of finding Pinch point temperature in this technology is carried out with two different ways, namely composite curve method and Problem table method. First method uses graphical analysis method (graph paper & scissors approach) and later uses an algorithm for setting the targets algebraically.

3.1 Composite Curve Method

A single composite of all hot and a single composite of all cold streams can be produced in the T/H diagram. Considering an example of two hot streams whose heat capacity-flow rate, CP (mass flow rate x specific heat at constant pressure) is A & B kW/ ° C. Graphical construction is briefly shown in fig 2.

In Figure 2 (a) their hot streams are plotted separately, with their supply and target temperature defining a series of “interval” temperature T_1 to T_2 . Between T_1 and T_2 only stream B exists, and so the heat available in this interval is given by $CP_B \cdot (T_1 - T_2)$. However between T_2 and T_3 both streams exists and so the heat available in this interval is $(CP_A + CP_B)(T_2 - T_3)$. A series of value of ΔH for each interval can be obtained in this way, and the result re-plotted against the interval temperature as shown is Figure 2. (b). The resulting T/H plot is a single curve representing all the hot streams. A similar procedure gives a composite of all cold streams in a problem.

Figure 3 shows a typical pair of composite curves. Shifting of the curves leads to behavior similar to that shown by the two-stream problem. Now, though, the “kinked” nature of composites means that ΔT_{min} can occur anywhere in the interchange region and not just at one end. For a given value of ΔT_{min} the utility

quantities predicted are the minima required to solve the heat recovery problem. Note that although there are many streams in the problem, in general ΔT_{\min} occurs at

only one point, termed the “pinch”. This means that it is possible to design a network, which uses the minimum utility requirements, where only the heat exchangers at the pinch need to operate at ΔT values down to ΔT_{\min} .

The overlap between the composite curves represents the maximum amount of heat recovery possible within the process. The “over-shoot” of the hot composite represents the minimum amount of external cooling required and the “over-shoot” of the cold composite represents the minimum amount of external heating. Because of the “kinked” nature of the curves, they approach most closely at one point. This is the “pinch”. Remaining procedure is common with next method.

3.2 Problem Table Method

Taking a case study of Ammonia-II plant, GSFC fertilizer complex, data from technical dept. was provided. From Process flow diagrams of whole plant, a problem is identified as Table-1.

The hot and cold streams in a process can be represented on a temperature-heat content (enthalpy) graph once there input and output temperatures (or “supply” and “target” temperatures) and their flow rates and physical properties are known.

Streams are shown in a scheme representation with a vertical temperature scale. Temperature interval boundaries are superimposed. The interval boundary temperatures are set as $\frac{1}{2} \Delta T_{\min}$ (5°C in this example) below hot stream temperature and $\frac{1}{2} \Delta T_{\min}$ above cold stream temperature. This data can be graphically presented as per fig. 4

Setting up the intervals in this way guarantees that full heat interchange within any interval is possible. Hence, each interval will have either a net surplus or net deficit of heat as indicated by enthalpy balance, but never both. This is shown in fig 5(a). Knowing the stream population in each interval, enthalpy balances can easily be calculated for each according to:-

$$\Delta H_i = (T_i - T_{i+1}) \times (\sum CP_C - \sum CP_H)_i \text{ for any interval } i.$$

Exploit a key feature of the temperature intervals. Namely, any heat available in interval 1 is hot enough to supply any duty in interval $i + 1$. Instead of sending the 7080.08 kW of surplus heat from interval 1 into cold utility, it can be sent down into interval 2. It is therefore possible to set up heat “cascade” as shown in Figure 5(a). Assuming that no heat is supplied to the hottest interval (1) from hot utility, In second interval with surplus of 7080.08 kW, deficit of 15499.15 kW is added, resulting deficit of 8419.07kW is passed to interval 3. Then in interval 4, has a 173.38 kW surplus, hence after accepting the – 8419.07 kW it can be regarded as passing on a 8245.69 kW deficit to interval 4. After going through all intervals 57856.55 kW is the final cascaded energy to cold utility. This in face is the net enthalpy balance on the whole problem. Looking back at the heat flows between intervals in Heat Cascade fig 5(a), clearly the negative flow to 8419.07 kW between intervals 2 and 3 is thermodynamically infeasible. To make it just feasible (i.e. equal to zero), 8419.07 kW of heat must be added from hot utility as shown in fig 5(b), and cascaded right through the system. By enthalpy balance this means that all flows are increased by 8419.07 kW. The net result of 8419.07 kW hot and 66275.62 kW cold. Further, the position of the pinch has been located. This is at the 418°C interval boundary temperature (i.e. hot streams at 423°C and cold at 413°C) where the heat flow is zero.

So for the designer wishing to produce a minimum utility design, the firm message is:-

- Don't transfer heat across the Pinch.
- Don't use Cold utilities above.
- Don't use Hot utilities below.

4. DESIGN FOR MAXIMUM ENERGY RECOVERY (MER)

The data in Table 1 were analyzed by the Problem Table method with the result that the minimum utility requirements are 8419.07 kW hot and 66275.62 kW cold. The pinch occurs where the hot streams are at 423^o C and the cold at 413^o C.

Briefly this design was produced by

- Dividing the problems at the pinch, and designing each part separately.
- Starting the design at the pinch and moving away.
- Immediately adjacent to the pinch, obeying constraints:
 $CP_{HOT} \leq CP_{COLD}$ (above pinch temp)
 $CP_{HOT} \geq CP_{COLD}$ (below pinch temp)
- Maximizing exchanger loads.
- Supplying external heating only above the pinch, and external cool below the pinch.

Finally the problem is resulting on a sheet for MER (Maximum Energy Recovery), considering steam splitting for necessary conditions, trading off energy & targeting for minimum number of units, energy relaxation and breaking loops is shown in fig. 6

5. CONCLUSION

Comparing both existing and new designed network, following conclusions can be made:

1. Hot utility load of 49953.48 kW (in existing network) is reduced to 13731.9 kW; this will decrease overall running cost of plant significantly.
2. Cold utility load of 54255.81 kW (in existing network) is increased to 67432.01 kW, but running cost will not

affect much as cold water is freely available.

3. Number of heat exchangers used in network is reduced from 23 to 20 in new design, resulting in less capital cost and complexity.

ACKNOWLEDGEMENTS

The authors wish to express their sincere thanks to Gujarat State Fertilizer Corporation Limited (GSFC Ltd.) for granting permission and coordination for the present work.

REFERENCES

1. B. Linnhoff, New concepts in thermodynamics for better chemical process design, Chem. Eng. Res. Des., 61, p207-223, 1983.
2. B. Linnhoff and E. Hindmarsh, The pinch design method for heat exchanger networks, Chem. Eng. Sci., 38,5, p745-763, 1983.
3. D. Boland and B. Linnhoff, The chemical engineer, 343, 222, 1979.
4. D. W. Townsend and B. Linnhoff, Heat and power network in process design, AIChE J., 29,5,p742-771(2-parts),1983.
5. R. A. Bowman et al Trans. ASME, 62, 283, 1940.
6. F. J. Steinmetz and M. O. Chaney, Total plant energy integration, CEP, p27-32, july, 1985.
7. B. Linnhoff and S. Ahmad, SUPERTARGETING: Optimum synthesis of energy management systems.
8. Dr. A. K. Sahoo, Pinch technology-theory into practice, sep. 1996.
9. E. Chem. User guide on process integration for the efficient use of energy, 1982.
10. B. Linnhoff and J. A. Turner, Heat recovery networks: New insights yield big saving, imperial chemical industries Ltd.
11. Y.K.Rastogi, Chemical industry digest: Special issue on energy conservation, October, 1994.
12. A. M. Whistler, Heat exchangers as money makers, petroleum refiner, 27,1,p83-86, 1948.
13. A. Saboo, Improved utility and cost targeting for heat exchanger networks.

14. E. C. Hohmann, Optimum Networks for heat exchange, Ph.D. Thesis, University of Southern California, USA, 1971.

15. J. L. Su, A loop-breaking evolutionary method for the synthesis heat exchanger networks, M.S. Thesis, Washington University, USA, 1979.

S. P. Patel, Pinch technology used for heat exchanger network, M.E. Thesis, M.S. University, India, 1999.

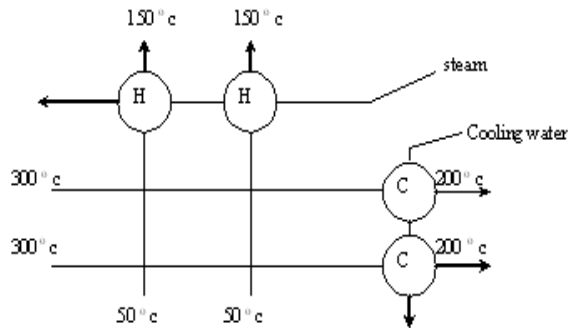

Fig 1(a) Networks for minimum capital cost

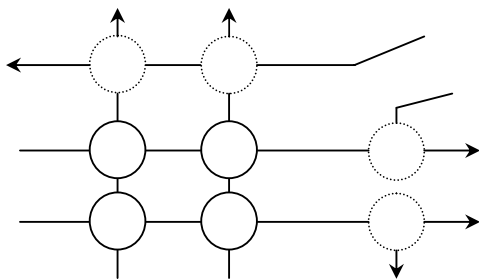

Fig. 1(b) Network for minimum energy cost

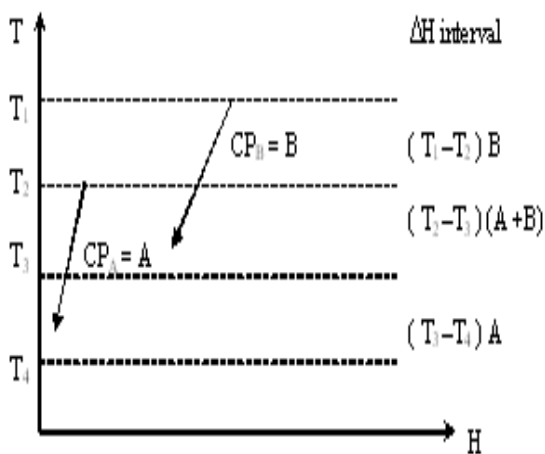

Figure 2(a) Construction of Hot Composite curve

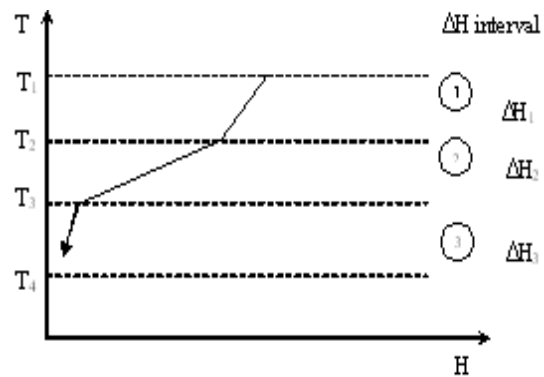

Fig. 2(b) Hot Composite curve

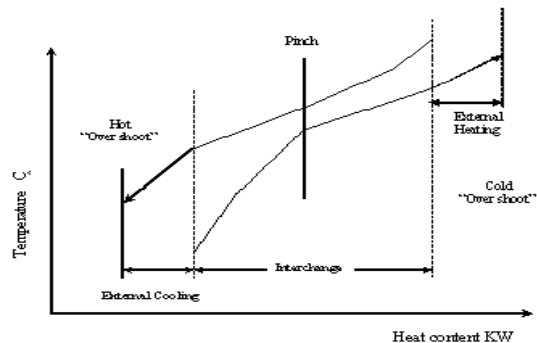

Figure 3: Typical pair of composite curves and Pinchpoint determination

Sr. No.	Stream	CP KW/°C	T ₁ °C	T ₂ °C	Load kW
1	Cold	10.327	15	382	3790
2	Cold	92.482	360	812	41801.86
3	Hot	53.637	954	360	31860.37
4	Hot	44.438	423	221	8976.47
5	Hot	126.245	235	172	7953.43
6	Cold	22.867	70	340	6174.09
7	Hot	24.171	370	40	7976.43
8	Cold	77.075	108	248	10790.5
9	Cold	22.71	15	207	4360.32
10	Cold	576.92	93	119	15000
11	Hot	429.28	172	135	15883.36
12	Hot	338.94	125	78	15930.23
13	Hot	199.15	103	40	12546.45
14	Hot	326.8	127	70	18627.88
15	Hot	134.016	218	41	23720.8
16	Cold	73.047	108	147	2848.83
17	Cold	5.305	60	163	546.41
18	Hot	4.076	214	40	709.224

Table -1 A Problem Of Ammonia - II plant at GSFC Fertilizer Complex
Hotutility: Purge & Associated gas at 1050 °C
Coldutility: Water at 15 °C

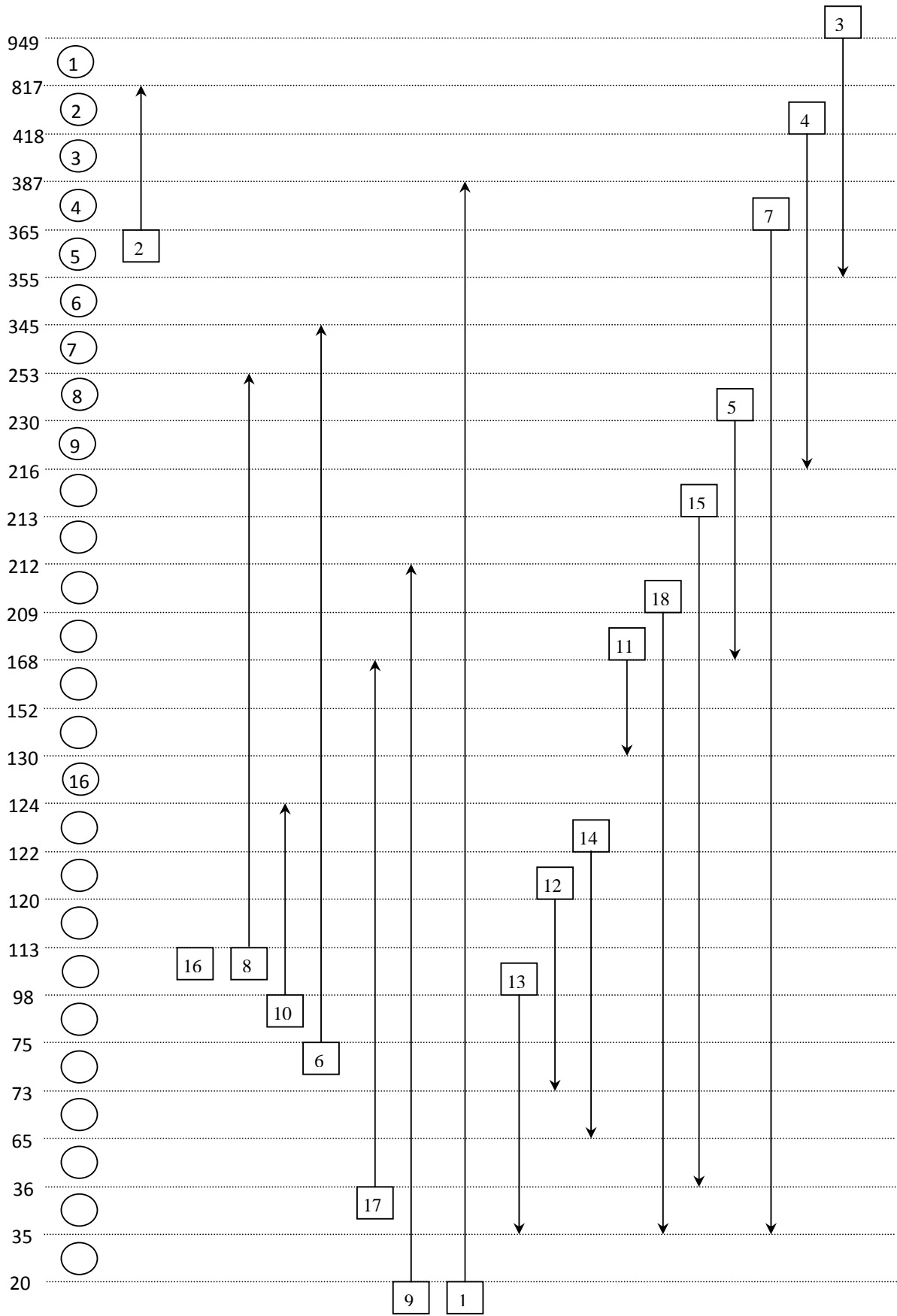

Fig. 4 Stream Requirements

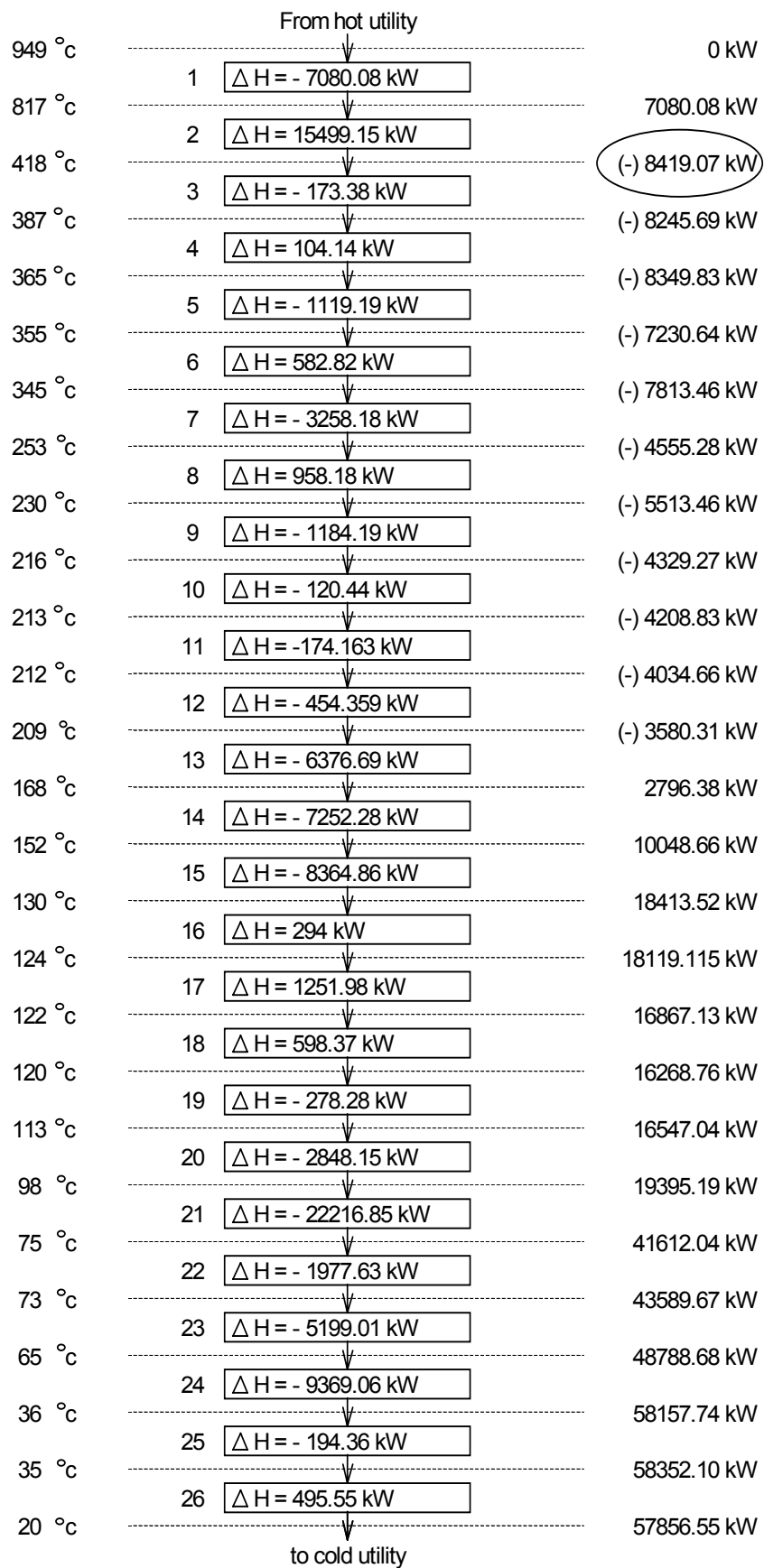

Fig. 5 (a) Heat Cascade (Feasible)

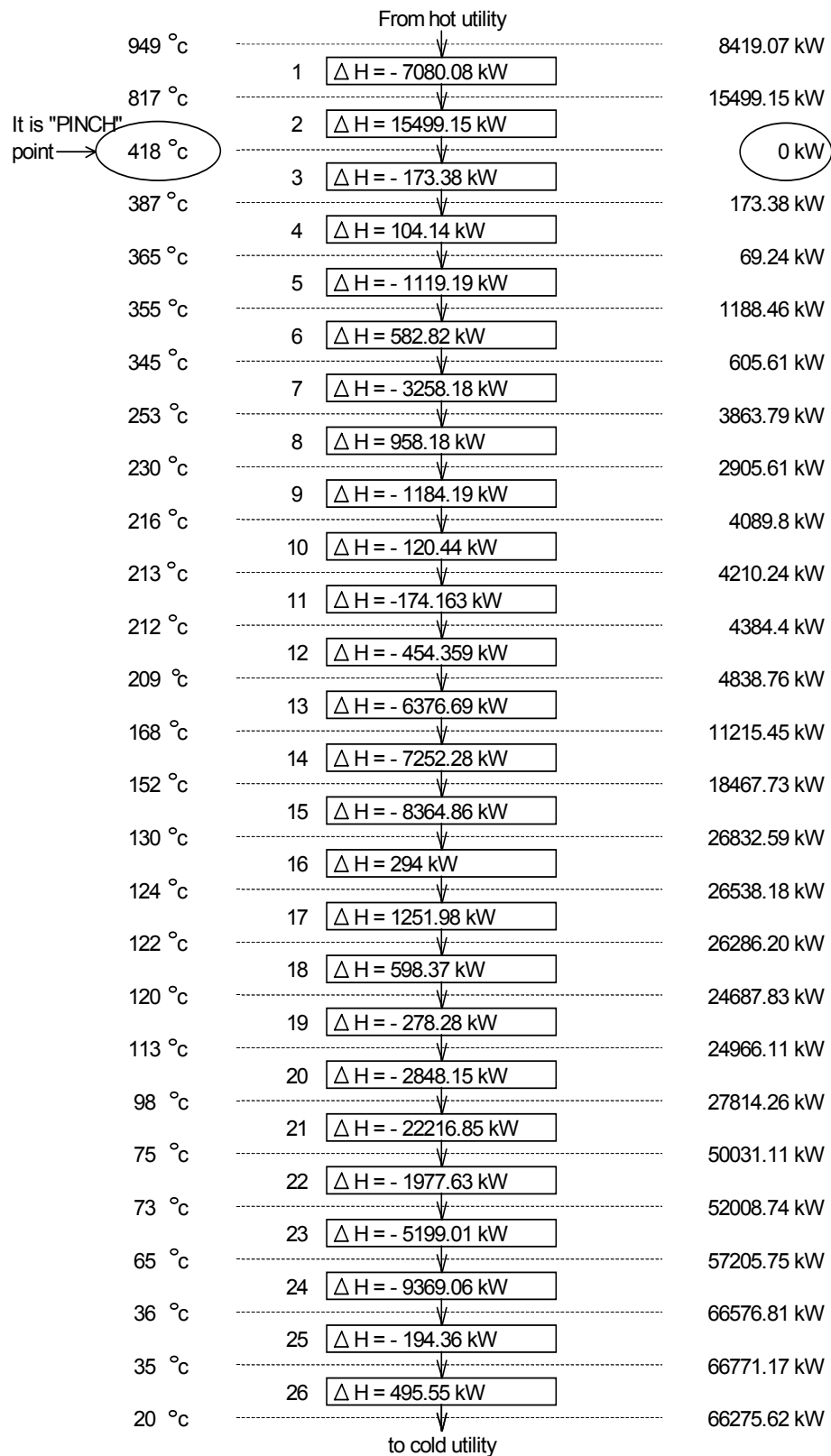

Fig. 5 (b) Heat Cascade (Feasible)

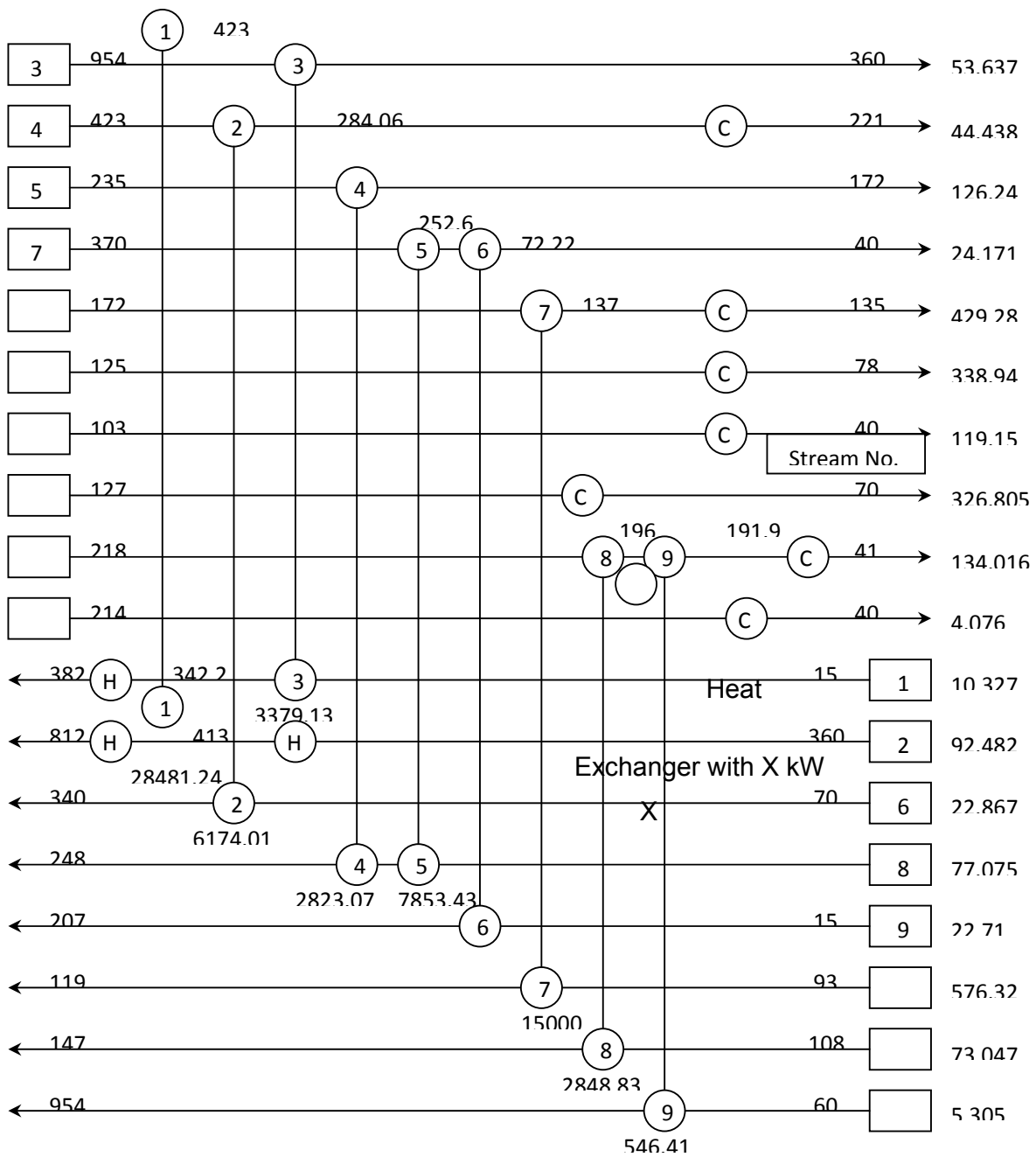

Fig. 6 Optimum Network Diagram for HEN